



MINISTRY OF HEALTH

LIST EQUIPMENT

BAND 1 (pages 3-58)

BAND 2 & 3 (pages 59-92)



MINISTRY OF HEALTH

LIST EQUIPMENT BAND 1

TABLE OF CONTENTS

BAND 1 SUBSTITUTES

- Equipment on the Band 1 List may be substituted for a similar product with essentially the same form and function.
- Where a substitute item is available from the stores, this **WILL** be issued first rather than buying new. As this is an automated process there is no ability to select exact item.
- If an exact Band 1 item is required and no substitute is acceptable, please complete via a Band 2 application with rationale to ensure exact item.

REHABILITATION EQUIPMENT	PAGE NUMBER
AMBULATORY MOBILITY	5
BEDROOM	10
COMMUNICATION ASSISTIVE TECHNOLOGY	14
HEARING ASSISTIVE TECHNOLOGY	15
KITCHEN & LIVING	21
MANUAL HANDLING	28
PAEDIATRIC	30
SHOWER & BATH	35
TOILETING	40
WHEELCHAIRS & SEATING	43
PRODUCTS UNDER \$50	48

MINISTRY OF HEALTH BAND 1 LIST EQUIPMENT





AMBULATORY MOBILITY

Walking Frame		Band 1	
		SPECIFICATIONS	
		Folding Lightweight aluminium 4 stoppers	
SUPPLIER		DIMENSIONS	
USL Medical		500mm overall width 690-810mm adjustable height	
BRAND		MAX USER WEIGHT	
USL Medical		100kg	
SUPPLIER PRODUCT ID	JDE#	PRICE BREAK	ORDERING CODE
C-0301	834030	\$50-\$250	WF5

Walking Frame		Band 1	
		SPECIFICATIONS	
		Folding 4 stoppers	
SUPPLIER		DIMENSIONS	
Invacare New Zealand		600mm overall width 770-950mm adjustable height	
BRAND		MAX USER WEIGHT	
Invacare New Zealand		136kg	
SUPPLIER PRODUCT ID	JDE#	PRICE BREAK	ORDERING CODE
6291-A	834259	\$50-\$250	WF36

MINISTRY OF HEALTH BAND 1 LIST EQUIPMENT



AMBULATORY MOBILITY



Walking Frame					Band 1
 			SPECIFICATIONS Folding Lightweight aluminium		
SUPPLIER			DIMENSIONS		
Tubular Equipment			610mm overall width 790-920mm adjustable height		
BRAND			MAX USER WEIGHT		
Tubular Equipment			160kg		
SUPPLIER PRODUCT ID	JDE#	SPECIFICATIONS	PRICE BREAK	ORDERING CODE	DHB SERVICE ACCREDITATION
AF1103G	773548	Front castors / rear glide feet	\$250-\$500	WF6	No
AF1102G	773601	Front wheels / rear glide feet	\$50-\$250	WF9	Yes
AF1103	773564	Front castors / rear stoppers	\$250-\$500	WF7	No
AF1102	773628	Front wheels / rear stoppers	\$50-\$250	WF10	No
Accessories					
DESCRIPTION	JDE#	SUPPLIER PRODUCT ID	PRICE BREAK	ORDERING CODE	DHB SERVICE ACCREDITATION
Basket/tray	830400	BSKT88	\$50-\$250	PA26	Yes
Walking Frame					Band 1
 			SPECIFICATIONS Narrow Lightweight aluminium Premium stroller/rollator narrow 4 wheels Standard with bag		
SUPPLIER			DIMENSIONS		
Goldfern Mobility			475mm overall width 770-900mm adjustable height		
BRAND			MAX USER WEIGHT		
Goldfern Mobility			127kg		
SUPPLIER PRODUCT ID	JDE#	PRICE BREAK	ORDERING CODE		
GM-TMA8350RIT-N-BLK	830848	\$50-\$250	WF43		
Accessories					
DESCRIPTION	JDE#	SUPPLIER PRODUCT ID	PRICE BREAK	ORDERING CODE	DHB SERVICE ACCREDITATION
Wire basket	830856	GM-TMA-RS22-N	Under \$50	WF45	Yes
Long handle kit with cable	830881	GMP-TMALHKWC	\$50-\$250	WF48	No
Tray	833504	GMP-TMA-12-007	\$50-\$250	WF49	Yes

© All contents within this document are the copyrighted property of Enable New Zealand. Contents may not be copied, reproduced, modified, published, uploaded, posted, transmitted or distributed in any way without the prior written consent of Enable New Zealand.

MINISTRY OF HEALTH BAND 1 LIST EQUIPMENT



AMBULATORY MOBILITY

Walking Frame						Band 1
 			SPECIFICATIONS Lightweight aluminium Premium stroller/rollator 4 wheels Standard with bag			
SUPPLIER			DIMENSIONS			
Goldfern Mobility			Standard Supplied with 6" wheels 590mm overall width 830-910mm adj. height		Optional Supplied with 8" wheels 590mm overall width 870-950mm adj. height	
BRAND			MAX USER WEIGHT			
Goldfern Mobility			127kg			
SUPPLIER PRODUCT ID	JDE#	SPECIFICATIONS	PRICE BREAK	ORDERING CODE	DHB SERVICE ACCREDITATION	
GM-TMA8350RITBLK	830899	6" wheels (standard)	\$50-\$250	WF40	Yes	
GM-TMA8350RIT185	837804	8" wheels (optional)	\$50-\$250	WF51	No	
Accessories						
DESCRIPTION	JDE#	SUPPLIER PRODUCT ID	PRICE BREAK	ORDERING CODE	DHB SERVICE ACCREDITATION	
Wire basket	830856	GM-TMA-RS22-N	Under \$50	WF45	Yes	
Curved bar	830872	GMP-TMACBAR	Under \$50	WF47	No	
Long handle kit with cable	830881	GMP-TMALHKWC	\$50-\$250	WF48	No	
Tray	833504	GMP-TMA-12-007	\$50-\$250	WF49	Yes	

Walking Frame						Band 1
 			SPECIFICATIONS Pacer Folding Front castors / rear wheels Handbrake Standard with basket and tray			
SUPPLIER			DIMENSIONS			
Cubro			570mm overall width 780-990mm adjustable height			
BRAND			MAX USER WEIGHT			
Pacer			160kg			
SUPPLIER PRODUCT ID	JDE#	PRICE BREAK	ORDERING CODE			
1875HB	754144	\$250-\$500	WF53			

MINISTRY OF HEALTH BAND 1 LIST EQUIPMENT

AMBULATORY MOBILITY

Walking Frame			Band 1		
 			SPECIFICATIONS Pacer Folding Standard with basket and tray		
SUPPLIER			DIMENSIONS		
Cubro			570mm overall width 755-990mm adjustable height		
BRAND			MAX USER WEIGHT		
Pacer			160kg		
SUPPLIER PRODUCT ID	JDE#	SPECIFICATIONS	PRICE BREAK	ORDERING CODE	DHB SERVICE ACCREDITATION
1875	754451	Front castors / rear wheels	\$250-\$500	WF22	Yes
1873	754443	Front castors / rear stoppers	\$250-\$500	WF21	No
1877	754435	Front castors / rear skis	\$250-\$500	WF20	No
1871	754478	Front wheels / rear stoppers	\$250-\$500	WF24	No
1872	754460	Front wheels / rear skis	\$250-\$500	WF23	No

Walking Frame			Band 1		
			SPECIFICATIONS Bariatric High strength tubing 4 wheels		
SUPPLIER			DIMENSIONS		
Allied Medical Ltd			735mm overall width 875-980mm adjustable height		
BRAND			MAX USER WEIGHT		
Maxhealth			230kg		
SUPPLIER PRODUCT ID	JDE#	PRICE BREAK	ORDERING CODE		
MP10200	829038	\$50-\$250	WF25		

MINISTRY OF HEALTH BAND 1 LIST EQUIPMENT

AMBULATORY MOBILITY



Walking Frame					Band 1
			SPECIFICATIONS		
			Adjustable forearm support		
SUPPLIER			DIMENSIONS		
Cubro			475mm overall width 800-1250mm adjustable height		
BRAND			MAX USER WEIGHT		
Pacer			160kg		
SUPPLIER PRODUCT ID	JDE#	SPECIFICATIONS	PRICE BREAK	ORDERING CODE	
1906	754734	Front castors / rear skis	\$250-\$500	WF18	
1905	754742	Front castors / rear wheels	\$250-\$500	WF19	
Accessories					
DESCRIPTION	JDE#	SUPPLIER PRODUCT ID	PRICE BREAK	ORDERING CODE	
Basket/tray	766022	1642	\$50-\$250	WF107	

Walking Frame					Band 1
			SPECIFICATIONS		
			Adjustable forearm support Front castors / rear wheels		
SUPPLIER			DIMENSIONS		
Tubular Equipment			460mm width (inside back legs) 920-1200mm adjustable height (trough)		
BRAND			MAX USER WEIGHT		
Tubular Equipment			200kg		
SUPPLIER PRODUCT ID	JDE#	PRICE BREAK	ORDERING CODE		
EFR1007C	834241	\$500-\$750	WF26		
Accessories					
DESCRIPTION	JDE#	SUPPLIER PRODUCT ID	PRICE BREAK	ORDERING CODE	
Tray	841248	T500	\$50-\$250	PA27	

MINISTRY OF HEALTH BAND 1 LIST EQUIPMENT



BEDROOM



Bed Lever						Band 1
 			SPECIFICATIONS Wooden base with metal hoop			
SUPPLIER			DIMENSIONS			
Tastech Services Ltd			290mm width of board			
BRAND			MAX USER WEIGHT			
Tastech Services Ltd			150kg			
SUPPLIER PRODUCT ID	JDE#	LOOP HEIGHT	BOARD LENGTH	PRICEBREAK	ORDERING CODE	DHB SERVICE ACCREDITATION
BL1-600	834056	550mm	600mm	\$50-\$250	B7	Yes
BL1	738988	550mm	800mm	\$50-\$250	B2	Yes
BLF-600	834275	550mm	600mm flat bottom	\$50-\$250	B1	No
BLF	834048	550mm	800mm flat bottom	\$50-\$250	B65	No

Bed Pole				Band 1
 		SPECIFICATIONS Freestanding over bed pole		
SUPPLIER		DIMENSIONS		
Superquip Ltd		1785mm height 885mm min handle height		
BRAND		MAX USER WEIGHT		
Superquip		120kg		
SUPPLIER PRODUCT ID	JDE#	PRICE BREAK	ORDERING CODE	
070	759156	\$50-\$250	B4	

MINISTRY OF HEALTH BAND 1 LIST EQUIPMENT



BEDROOM



Overbed Table		Band 1	
 		SPECIFICATIONS Tilt top	
SUPPLIER		DIMENSIONS	
Invacare New Zealand		380x800mm top size 760-1050mm adjustable height	
BRAND		MAX USER WEIGHT	
Invacare New Zealand		N/A	
SUPPLIER PRODUCT ID	JDE#	PRICE BREAK	ORDERING CODE
6418	834283	\$50-\$250	B17

Overbed/chair Table		Band 1	
 		SPECIFICATIONS Tilt Top U Base	
SUPPLIER		DIMENSIONS	
Cubro		450x750mm top size 600-960mm adjustable height	
BRAND		MAX USER WEIGHT	
		N/A	
SUPPLIER PRODUCT ID	JDE#	PRICE BREAK	ORDERING CODE
575	876205	\$50-\$250	B259

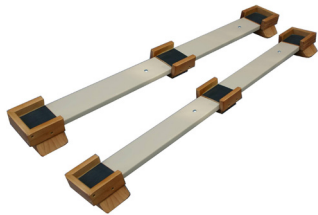
MINISTRY OF HEALTH BAND 1 LIST EQUIPMENT

BEDROOM

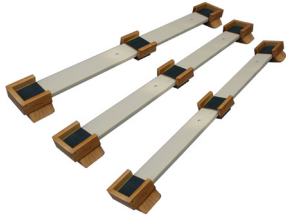
Bed Raiser		Band 1		
 		SPECIFICATIONS		
		Double bed raiser Set of 2 Suits all sizes of double beds that have legs, glides or castor wheels		
SUPPLIER		DIMENSIONS		
Multifit Hospital Supplies Ltd		90x90mm foot pad 150-1700mm adjustable width Standard double to Superking size		
BRAND		MAX USER WEIGHT		
Multifit Hospital Supplies		380kg		
SUPPLIER PRODUCT ID	JDE#	HEIGHT	PRICE BREAK	ORDERING CODE
MF2/4-50/2	760616	50mm	\$50-\$250	K14-50/2
MF2/4-75/2	760632	75mm	\$50-\$250	K14-75/2
MF2/4-100/2	760579	100mm	\$50-\$250	K14-100/2
MF2/4-150/2	760595	150mm	\$50-\$250	K14-150/2

Bed Raiser		Band 1		
 		SPECIFICATIONS		
		Double bed raiser Set of 3 Suits all sizes of double beds that have legs, glides or castor wheels		
SUPPLIER		DIMENSIONS		
Multifit Hospital Supplies Ltd		90x90mm foot pad 150-1700mm adjustable width Standard double to Superking size		
BRAND		MAX USER WEIGHT		
Multifit Hospital Supplies		380kg		
SUPPLIER PRODUCT ID	JDE#	HEIGHT	PRICE BREAK	ORDERING CODE
MF2/4-50/3	760624	50mm	\$250-\$500	K15-50/3
MF2/4-75/3	760641	75mm	\$250-\$500	K15-75/3
MF2/4-100/3	760587	100mm	\$250-\$500	K15-100/3
MF2/4-150/3	760608	150mm	\$250-\$500	K15-150/3

MINISTRY OF HEALTH BAND 1 LIST EQUIPMENT

BEDROOM

Bed Raiser		Band 1		
 		SPECIFICATIONS Single bed troughs Set of 3 Suits single beds that have legs, glides or castor wheels		
SUPPLIER		DIMENSIONS		
Multifit Hospital Supplies Ltd		90 x 90mm foot pad 815-1100mm adjustable width		
BRAND		MAX USER WEIGHT		
Multifit Hospital Supplies		380kg		
SUPPLIER PRODUCT ID	JDE#	HEIGHT	PRICE BREAK	ORDERING CODE
MF2/2-50/3	760712	50mm	\$250-\$500	K16-50/3
MF2/2-75/3	760691	75mm	\$250-\$500	K16-75/3
MF2/2-100/3	760683	100mm	\$250-\$500	K16-100/3
MF2/2-150/3	760704	150mm	\$250-\$500	K16-150/3

MINISTRY OF HEALTH BAND 1 LIST EQUIPMENT

COMMUNICATION ASSISTIVE TECHNOLOGY

Artificial Larynges		Band 1	
		SPECIFICATIONS	
		Electrolarynx Nu-Vois III	
SUPPLIER		DIMENSIONS	
Atos Medical			
BRAND		MAX USER WEIGHT	
Nu-Vois		N/A	
SUPPLIER PRODUCT ID	JDE#	PRICE BREAK	ORDERING CODE
MPNUVOIS3	733319	Over \$1000	CM11

MINISTRY OF HEALTH BAND 1 LIST EQUIPMENT

HEARING ASSISTIVE TECHNOLOGY

Alarm Clock		Band 1	
		SPECIFICATIONS	
		Visit alarm clock with wireless receiver and shaker	
SUPPLIER		DIMENSIONS	
Reid Technology			
BRAND		MAX USER WEIGHT	
Bellman		N/A	
SUPPLIER PRODUCT ID	JDE#	PRICE BREAK	ORDERING CODE
BE1380	835569	\$50-\$250	CM12

Door Alarm Transmitter		Band 1	
		SPECIFICATIONS	
		Visit wireless doorbell Push button door / alarm transmitter	
SUPPLIER		DIMENSIONS	
Reid Technology			
BRAND		MAX USER WEIGHT	
Bellman		N/A	
SUPPLIER PRODUCT ID	JDE#	PRICE BREAK	ORDERING CODE
BE1240	831568	\$50-\$250	CM2

Baby Transmitter		Band 1	
		SPECIFICATIONS	
		Visit baby monitor Baby cry transmitter	
SUPPLIER		DIMENSIONS	
Reid Technology			
BRAND		MAX USER WEIGHT	
Bellman		N/A	
SUPPLIER PRODUCT ID	JDE#	PRICE BREAK	ORDERING CODE
BE1290	798585	\$250-\$500	CM4

MINISTRY OF HEALTH BAND 1 LIST EQUIPMENT

HEARING ASSISTIVE TECHNOLOGY

Portable Receiver		Band 1	
		SPECIFICATIONS	
		Visit portable receiver (battery powered)	
SUPPLIER		DIMENSIONS	
Reid Technology			
BRAND		MAX USER WEIGHT	
Bellman		N/A	
SUPPLIER PRODUCT ID	JDE#	PRICE BREAK	ORDERING CODE
BE1033	823728	\$50-\$250	CM5

Portable Receiver		Band 1	
		SPECIFICATIONS	
		Visit portable receiver (mains powered)	
SUPPLIER		DIMENSIONS	
Reid Technology			
BRAND		MAX USER WEIGHT	
Bellman		N/A	
SUPPLIER PRODUCT ID	JDE#	PRICE BREAK	ORDERING CODE
BE1034	796758	\$250-\$500	CM6

Telephone Transmitter		Band 1	
		SPECIFICATIONS	
		Visit telephone transmitter	
SUPPLIER		DIMENSIONS	
Reid Technology			
BRAND		MAX USER WEIGHT	
Bellman		N/A	
SUPPLIER PRODUCT ID	JDE#	PRICE BREAK	ORDERING CODE
BE1123	808376	\$50-\$250	CM13

MINISTRY OF HEALTH BAND 1 LIST EQUIPMENT

HEARING ASSISTIVE TECHNOLOGY

Bed/Pillow Shaker		Band 1	
		SPECIFICATIONS	
		Bed shaker	
SUPPLIER		DIMENSIONS	
Reid Technology			
BRAND		MAX USER WEIGHT	
Bellman		N/A	
SUPPLIER PRODUCT ID	JDE#	PRICE BREAK	ORDERING CODE
BE1270	798260	\$50-\$250	CM3

Flash Receiver		Band 1	
		SPECIFICATIONS	
		Visit flash receiver	
SUPPLIER		DIMENSIONS	
Reid Technology			
BRAND		MAX USER WEIGHT	
Bellman		N/A	
SUPPLIER PRODUCT ID	JDE#	PRICE BREAK	ORDERING CODE
BE1443	805440	\$250-\$500	CM7

Smoke Alarm Transmitter		Band 1	
		SPECIFICATIONS	
		Visit Smoke Alarm	
SUPPLIER		DIMENSIONS	
Reid Technology			
BRAND		MAX USER WEIGHT	
Bellman		N/A	
SUPPLIER PRODUCT ID	JDE#	PRICE BREAK	ORDERING CODE
BE1287	869671	\$250-\$500	CM14

MINISTRY OF HEALTH BAND 1 LIST EQUIPMENT

HEARING ASSISTIVE TECHNOLOGY

Pager Receiver		Band 1	
		SPECIFICATIONS Visit pager receiver	
SUPPLIER		DIMENSIONS	
Reid Technology			
BRAND		MAX USER WEIGHT	
Bellman		N/A	
SUPPLIER PRODUCT ID	JDE#	PRICE BREAK	ORDERING CODE
BE1230	798577	\$250-\$500	CM8

Pager Charger		Band 1	
		SPECIFICATIONS Visit pager charger	
SUPPLIER		DIMENSIONS	
Reid Technology			
BRAND		MAX USER WEIGHT	
Bellman		N/A	
SUPPLIER PRODUCT ID	JDE#	PRICE BREAK	ORDERING CODE
BE1260	786381	\$50-\$250	CM9

MINISTRY OF HEALTH BAND 1 LIST EQUIPMENT

HEARING ASSISTIVE TECHNOLOGY

Smoke Alarm Controller		Band 1	
		SPECIFICATIONS	
		RadioLINK Alarm Controller	
SUPPLIER		DIMENSIONS	
Brooks			
BRAND		MAX USER WEIGHT	
EI Electronics		N/A	
SUPPLIER PRODUCT ID	JDE#	PRICE BREAK	ORDERING CODE
EIB450	869689	\$50-\$250	CM15

Strobe Light/Vibrating Pad		Band 1	
		SPECIFICATIONS	
		RadioLINK Strobe Light & Vibration Pad Module	
SUPPLIER		DIMENSIONS	
Brooks			
BRAND		MAX USER WEIGHT	
EI Electronics		N/A	
SUPPLIER PRODUCT ID	JDE#	PRICE BREAK	ORDERING CODE
EIB170RF	869697	\$250-\$500	CM16

Smoke Alarm		Band 1	
		SPECIFICATIONS	
		RadioLINK Smoke Alarm	
SUPPLIER		DIMENSIONS	
Brooks			
BRAND		MAX USER WEIGHT	
EI Electronics		N/A	
SUPPLIER PRODUCT ID	JDE#	PRICE BREAK	ORDERING CODE
EIB650ICRF	869700	\$50-\$250	CM17

MINISTRY OF HEALTH BAND 1 LIST EQUIPMENT

HEARING ASSISTIVE TECHNOLOGY



Strobe Light Only		Band 1	
		SPECIFICATIONS	
		RadioLINK Strobe Light only	
SUPPLIER		DIMENSIONS	
Brooks			
BRAND		MAX USER WEIGHT	
EI Electronics		N/A	
SUPPLIER PRODUCT ID	JDE#	PRICE BREAK	ORDERING CODE
EIB171RF	869718	\$250-\$500	CM18

Vibrating Pad Only		Band 1	
		SPECIFICATIONS	
		RadioLINK Vibration Pad only	
SUPPLIER		DIMENSIONS	
Brooks			
BRAND		MAX USER WEIGHT	
EI Electronics		N/A	
SUPPLIER PRODUCT ID	JDE#	PRICE BREAK	ORDERING CODE
EIB174	869726	\$50-\$250	CM19

MINISTRY OF HEALTH BAND 1 LIST EQUIPMENT

KITCHEN & LIVING

Step With Handle		Band 1	
		SPECIFICATIONS	
		Bath step adjustable height Rust Free Aluminium Non slip mat.	
SUPPLIER		DIMENSIONS	
Goldfern Mobility		450x320mm step size 200-250mm platform height 1050-1100mm handle height	
BRAND		MAX USER WEIGHT	
Goldfern Mobility		130kg	
SUPPLIER PRODUCT ID	JDE#	PRICE BREAK	ORDERING CODE
GM-HMP-8335	869831	\$50-\$250	K4



Perching Stool with Arms		Band 1	
 		SPECIFICATIONS	
		Adjustable height	
SUPPLIER		DIMENSIONS	
Permobil		320mm seat width 490mm width between arms	
BRAND		MAX USER WEIGHT	
Maxhealth		113kg	
SUPPLIER PRODUCT ID	JDE#	PRICE BREAK	ORDERING CODE
KC100	764596	\$50-\$250	K9



Kitchen Trolley		Band 1	
 		SPECIFICATIONS	
		Without handle	
SUPPLIER		DIMENSIONS	
Tastech Services Ltd		430mm width 430mm depth 810mm height	
BRAND		MAX WEIGHT ON TRAY	
Tastech Services		30kg	
SUPPLIER PRODUCT ID	JDE#	PRICE BREAK	ORDERING CODE
RT1	766111	\$50-\$250	K8

© All contents within this document are the copyrighted property of Enable New Zealand. Contents may not be copied, reproduced, modified, published, uploaded, posted, transmitted or distributed in any way without the prior written consent of Enable New Zealand.

MINISTRY OF HEALTH BAND 1 LIST EQUIPMENT

KITCHEN & LIVING

Kitchen Trolley		Band 1	
 		SPECIFICATIONS With handle	
SUPPLIER		DIMENSIONS	
Tastech Services Ltd		430mm width 430mm depth 870mm height	
BRAND		MAX WEIGHT ON TRAY	
Tastech Services		30kg	
SUPPLIER PRODUCT ID	JDE#	PRICE BREAK	ORDERING CODE
RT1H	766102	\$50-\$250	K8-H

Kitchen Trolley		Band 1	
 		SPECIFICATIONS	
SUPPLIER		DIMENSIONS	
Cubro		465mm width 490mm length 785-935mm adjustable height	
BRAND		MAX WEIGHT ON TRAY	
Chevron		10kg	
SUPPLIER PRODUCT ID	JDE#	PRICE BREAK	ORDERING CODE
290	766081	\$50-\$250	K11

MINISTRY OF HEALTH BAND 1 LIST EQUIPMENT

KITCHEN & LIVING

Chair/Bed Blocks					Band 1
			SPECIFICATIONS		
			Set of 4		
SUPPLIER			DIMENSIONS		
Tastech Services Ltd			130x130mm size		
BRAND			MAX USER WEIGHT		
Tastech Services			600kg		
SUPPLIER PRODUCT ID	JDE#	HEIGHT	PRICE BREAK	ORDERING CODE	
CB1-4	810601	50mm	\$50-\$250	K12-50 4	
CB2-4	810628	75mm	\$50-\$250	K12-75 4	
CB3-4	810564	100mm	\$50-\$250	K12-100 4	
CB4-4	810581	150mm	\$50-\$250	K12-150 4	

Chair/Bed Blocks					Band 1
			SPECIFICATIONS		
			Set of 6		
SUPPLIER			DIMENSIONS		
Tastech Services Ltd			130x130mm size		
BRAND			MAX USER WEIGHT		
Tastech Services			600kg		
SUPPLIER PRODUCT ID	JDE#	HEIGHT	PRICE BREAK	ORDERING CODE	
CB1-6	810599	50mm	\$50-\$250	K12-50 6	
CB2-6	810610	75mm	\$50-\$250	K12-75 6	
CB3-6	810556	100mm	\$50-\$250	K12-100 6	
CB4-6	810572	150mm	\$50-\$250	K12-150 6	

MINISTRY OF HEALTH BAND 1 LIST EQUIPMENT

KITCHEN & LIVING

Chair/Bed Blocks		Band 1		
		SPECIFICATIONS Castors Set of 4		
SUPPLIER		DIMENSIONS		
Tastech Services Ltd		130x130mm size		
BRAND		MAX USER WEIGHT		
Tastech Services		600kg		
SUPPLIER PRODUCT ID	JDE#	HEIGHT	PRICE BREAK	ORDERING CODE
CB1C-4	810521	50mm	\$50-\$250	K12-50C 4
CB2C-4	810548	75mm	\$50-\$250	K12-75C 4
CB3C-4	810484	100mm	\$50-\$250	K12-100C 4
CB4C-4	810505	150mm	\$50-\$250	K12-150C 4

Chair/Bed Blocks		Band 1		
		SPECIFICATIONS Castors Set of 6		
SUPPLIER		DIMENSIONS		
Tastech Services Ltd		130x130mm size		
BRAND		MAX USER WEIGHT		
Tastech Services		600kg		
SUPPLIER PRODUCT ID	JDE#	HEIGHT	PRICE BREAK	ORDERING CODE
CB1C-6	810513	50mm	\$50-\$250	K12-50C 6
CB2C-6	810530	75mm	\$50-\$250	K12-75C 6
CB3C-6	810476	100mm	\$50-\$250	K12-100C 6
CB4C-6	810492	150mm	\$50-\$250	K12-150C 6

MINISTRY OF HEALTH BAND 1 LIST EQUIPMENT

KITCHEN & LIVING

Sofa Raiser

Band 1

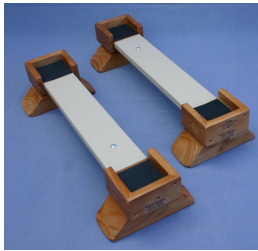

SPECIFICATIONS

Set of 2
Fits any standard sofa that has legs, glides or castor wheels

SUPPLIER

Multifit Hospital Supplies Ltd

DIMENSIONS

90x90mm foot pad size
624-900mm adjustable width

BRAND

Multifit Hospital Supplies

MAX USER WEIGHT

380kg

SUPPLIER PRODUCT ID	JDE#	HEIGHT	PRICE BREAK	ORDERING CODE
MF2/1-50/2	760747	50mm	\$50-\$250	K3-50/2
MF2/1-75/2	760755	75mm	\$50-\$250	K3-75/2
MF2/1-100/2	760721	100mm	\$50-\$250	K3-100/2
MF2/1-150/2	760739	150mm	\$50-\$250	K3-150/2

Chair Raiser Platform

Band 1

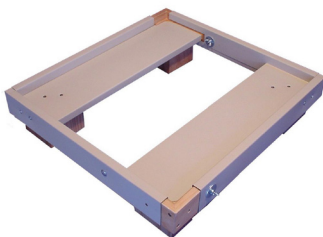

SPECIFICATIONS

Standard Chair
Suits most square shape lounge chairs

SUPPLIER

Multifit Hospital Supplies Ltd

DIMENSIONS

438-816mm adjustable width
528-873mm adjustable length

BRAND

Multifit Hospital Supplies



MAX USER WEIGHT



380kg over 4 feet

SUPPLIER PRODUCT ID	JDE#	HEIGHT	PRICE BREAK	ORDERING CODE
MF1/1-50	760384	50mm	\$50-\$250	K1-50
MF1/1-75	760392	75mm	\$50-\$250	K1-75
MF1/1-100	760368	100mm	\$50-\$250	K1-100
MF1/1-150	760376	150mm	\$50-\$250	K1-150

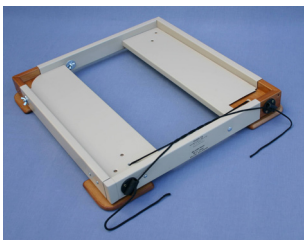
MINISTRY OF HEALTH BAND 1 LIST EQUIPMENT

KITCHEN & LIVING

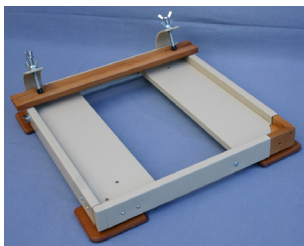
Chair Raiser Platform		Band 1		
 		SPECIFICATIONS Big Softie Style Suits most rocking/recliner chairs that have a steel tube base		
SUPPLIER		DIMENSIONS		
Multifit Hospital Supplies Ltd		485-710mm adjustable width 530-885mm adjustable length		
BRAND		MAX USER WEIGHT		
Multifit Hospital Supplies		380kg over 4 feet		
SUPPLIER PRODUCT ID	JDE#	HEIGHT	PRICE BREAK	ORDERING CODE
MF1/7-50	760421	50mm	\$250-\$500	K13-50
MF1/7-75	760430	75mm	\$250-\$500	K13-75
MF1/7-100	760405	100mm	\$250-\$500	K13-100
MF1/7-150	760413	150mm	\$250-\$500	K13-150

Chair Raiser Platform		Band 1		
 		SPECIFICATIONS Lazy Boy Style Suits LazyBoy style chair which have wooden runners that extend past the rear of the chair base		
SUPPLIER		DIMENSIONS		
Multifit Hospital Supplies Ltd		485-710mm adjustable width 530-885mm adjustable length		
BRAND		MAX USER WEIGHT		
Multifit Hospital Supplies		380kg over 4 feet		
SUPPLIER PRODUCT ID	JDE#	HEIGHT	PRICE BREAK	ORDERING CODE
MF1/3-50	760464	50mm	\$250-\$500	K2-50
MF1/3-75	760472	75mm	\$250-\$500	K2-75
MF1/3-100	760448	100mm	\$250-\$500	K2-100
MF1/3-150	760456	150mm	\$250-\$500	K2-150

MINISTRY OF HEALTH BAND 1 LIST EQUIPMENT

KITCHEN & LIVING

Chair		Band 1	
		SPECIFICATIONS	
		Rehab chair Multi-purpose	
SUPPLIER		DIMENSIONS	
Cubro		430 - 580mm adjustable height 440mm width between arms 430mm seat width 440mm seat depth	
BRAND		MAX USER WEIGHT	
Viking		200kg	
SUPPLIER PRODUCT ID	JDE#	PRICE BREAK	ORDERING CODE
609S	740762	\$250-\$500	K5-U

MINISTRY OF HEALTH BAND 1 LIST EQUIPMENT

MANUAL HANDLING

Transfer Board		Band 1	
		SPECIFICATIONS	
		Plastic construction Curved board	
SUPPLIER		DIMENSIONS	
Tastech Services Ltd		660mm long 200mm wide	
BRAND		MAX USER WEIGHT	
Tastech Services		110kg	
SUPPLIER PRODUCT ID	JDE#	PRICE BREAK	ORDERING CODE
TBP2	834312	\$50-\$250	TB68

Transfer Belt		Band 1	
		SPECIFICATIONS	
		Small Orange 7 handles	
SUPPLIER		DIMENSIONS	
USL Medical		600 / 1000mm length	
BRAND		MAX USER WEIGHT	
LIKO		200kg	
SUPPLIER PRODUCT ID	JDE#	PRICE BREAK	ORDERING CODE
L3760014	834304	\$50-\$250	TB1

Transfer Belt		Band 1	
		SPECIFICATIONS	
		Medium Yellow 9 handles	
SUPPLIER		DIMENSIONS	
USL Medical		750 / 1200mm length	
BRAND		MAX USER WEIGHT	
LIKO		200kg	
SUPPLIER PRODUCT ID	JDE#	PRICE BREAK	ORDERING CODE
L3760015	827850	\$50-\$250	TB2

MINISTRY OF HEALTH BAND 1 LIST EQUIPMENT

MANUAL HANDLING

Transfer Belt		Band 1	
		SPECIFICATIONS	
		Large Blue 11 handles	
SUPPLIER		DIMENSIONS	
USL Medical		900 / 1400mm length	
BRAND		MAX USER WEIGHT	
LIKO		200kg	
SUPPLIER PRODUCT ID	JDE#	PRICE BREAK	ORDERING CODE
L3760016	826988	\$50-\$250	TB3

MINISTRY OF HEALTH BAND 1 LIST EQUIPMENT

PAEDIATRIC

Feeding ADL Band 1

		SPECIFICATIONS	
		Haberman feeder 2 teats	
SUPPLIER		DIMENSIONS	
Zabonne		150ml	
BRAND		MAX USER WEIGHT	
		N/A	
SUPPLIER PRODUCT ID	JDE#	PRICE BREAK	ORDERING CODE
FD-HF	796281	\$50-\$250	P152

Accessories

DESCRIPTION	JDE#	SUPPLIER PRODUCT ID	PRICE BREAK	ORDERING CODE
Haberman teat	845396	FD-HT	Under \$50	P153

Feeding ADL Band 1

		SPECIFICATIONS	
		Pigeon feeder 2 teats - 1 x large, 1 x small	
SUPPLIER		DIMENSIONS	
Zabonne		240ml	
BRAND		MAX USER WEIGHT	
		N/A	
SUPPLIER PRODUCT ID	JDE#	PRICE BREAK	ORDERING CODE
FD-PB-CP	802556	Under \$50	P167

Accessories

DESCRIPTION	JDE#	SUPPLIER PRODUCT ID	PRICE BREAK	ORDERING CODE
Pigeon teat small	848116	FD-PN-CP	Under \$50	P168

MINISTRY OF HEALTH BAND 1 LIST EQUIPMENT

PAEDIATRIC

Height Adjustable Chair

Band 1



SPECIFICATIONS

Wooden chair with adjustable seat and footrest

SUPPLIER		DIMENSIONS	
Viking Imports LTD		830x480x560mm	
BRAND		MAX USER WEIGHT	
DanChair		75kg	
SUPPLIER PRODUCT ID	JDE#	PRICE BREAK	ORDERING CODE
DanChair	877427	\$250-\$500	P49

Accessories

DESCRIPTION	JDE#	SUPPLIER PRODUCT ID	PRICE BREAK	ORDERING CODE
Large Tray	877435	DANCHAIR TRAY	\$250-\$500	P154
Seat/Footrest w Large Hip Groin Strap	877443	DANCHAIR LARGE SEAT	\$50-\$250	P155
Platform with legs	877451	DANCHAIR PLATFORM	\$50-\$250	P156

MINISTRY OF HEALTH BAND 1 LIST EQUIPMENT

PAEDIATRIC

Toilet Surround		Band 1	
		SPECIFICATIONS	
		Toilet Surround	
SUPPLIER		DIMENSIONS	
B M Enterprises		500mm width 600mm depth 525-725mm adjustable height	
BRAND		MAX USER WEIGHT	
		N/A	
SUPPLIER PRODUCT ID	JDE#	PRICE BREAK	ORDERING CODE
BM300	778592	\$50-\$250	P159

Toilet Surround		Band 1	
		SPECIFICATIONS	
		Toilet Surround with suction cup feet	
SUPPLIER		DIMENSIONS	
B M Enterprises		500mm width 600mm depth 525-725mm adjustable height	
BRAND		MAX USER WEIGHT	
		N/A	
SUPPLIER PRODUCT ID	JDE#	PRICE BREAK	ORDERING CODE
BM300SUC	840755	\$50-\$250	P160

MINISTRY OF HEALTH BAND 1 LIST EQUIPMENT

PAEDIATRIC

Bath Support							Band 1
				SPECIFICATIONS			
				Wrap-around bath support padded Low back			
SUPPLIER				DIMENSIONS			
Allied Medical				370mm Seat Depth 425mm Seat Width 700mm Length			
BRAND				MAX USER WEIGHT			
Columbia				N/A			
SUPPLIER PRODUCT ID	JDE#	SIZE	BACK HEIGHT RANGE	INSIDE BACK WIDTH	PRICE BREAK	ORDERING CODE	
COL7210	738697	Small	225-350mm	212.5mm	\$750-\$1000	P161	
COL7310	815058	Medium	250-350mm	312mm	\$750-\$1000	P162	
COL7410	845353	Large	270-400mm	362mm	\$750-\$1000	P163	

Bath Support							Band 1
				SPECIFICATIONS			
				Wrap-around bath support padded High back			
SUPPLIER				DIMENSIONS			
Allied Medical				362mm seat depth 425mm seat width 700mm length			
BRAND				MAX USER WEIGHT			
Columbia				N/A			
SUPPLIER PRODUCT ID	JDE#	SIZE	BACK HEIGHT RANGE	INSIDE BACK WIDTH	PRICE BREAK	ORDERING CODE	
COL7610	803031	Small	425-550mm	325mm	\$750-\$1000	P164	
COL7710	738689	Medium	475-600mm	325mm	\$750-\$1000	P165	
COL7910	845361	Large	600-700mm	325mm	\$750-\$1000	P166	

MINISTRY OF HEALTH BAND 1 LIST EQUIPMENT



PAEDIATRIC

Bath Chair							Band 1
				SPECIFICATIONS			
				Shower / bath system			
SUPPLIER				DIMENSIONS			
Medifab				370mm seat width			
BRAND							
Green bathe							
SUPPLIER PRODUCT ID	JDE#	SIZE	SEAT DEPTH	MAX USER WEIGHT	PRICEBREAK	ORDERING CODE	
6012 0000 000	740455	Medium	330mm	55kg	\$750-\$1000	P79	
6013 0000 000	740463	Large	420mm	72kg	\$750-\$1000	P80	
Accessories							
Description	JDE#	SUPPLIER PRODUCT ID	DIMENSIONS	MAX USER WEIGHT	PRICEBREAK	ORDERING CODE	
Tub Stand	835067	6010 8700 000	430mm width 130-250mm height adjustable	90kg	\$250-\$500	P81	
Mobile Shower Stand	835104	6110 8760 000	760mm seat to floor height 690mm base width 840mm base length	90kg	\$750-\$1000	P82	



MINISTRY OF HEALTH BAND 1 LIST EQUIPMENT

SHOWER & BATH



Bath Step Band 1

 		SPECIFICATIONS Bath step fixed height Rust Free Aluminium Non slip mat.		
SUPPLIER		DIMENSIONS		
Goldfern Mobility		450x320mm platform size		
BRAND		MAX USER WEIGHT		
Goldfern Mobility		180kg		
SUPPLIER PRODUCT ID	JDE#	HEIGHT	PRICE BREAK	ORDERING CODE
GM-HMP-8334	869806	140mm	\$50-\$250	S1
GM-HMP-8333	869814	140mm with handle	\$50-\$250	S13

Bathboard Band 1

 		SPECIFICATIONS Plastic construction		
SUPPLIER		DIMENSIONS		
Permobil		350mm board width		
BRAND		MAX USER WEIGHT		
Maxhealth		150kg		
SUPPLIER PRODUCT ID	JDE#	BOARD LENGTH	PRICE BREAK	ORDERING CODE
BE100	834321	690mm	\$50-\$250	S2
BE101	834339	740mm	\$50-\$250	S4

Transfer Bench Band 1

 		SPECIFICATIONS Transfer bench		
SUPPLIER		DIMENSIONS		
Cubro		470-585mm adjustable height 380-490mm bath clearance		
BRAND		MAX USER WEIGHT		
Oakwood		130kg		
SUPPLIER PRODUCT ID	JDE#	PRICE BREAK	ORDERING CODE	
256	739569	\$50-\$250	S16	

MINISTRY OF HEALTH BAND 1 LIST EQUIPMENT



SHOWER & BATH



Swivel Bather				Band 1	
			SPECIFICATIONS		
			Swivel bather See below for height options		
SUPPLIER			DIMENSIONS		
Cubro			470mm width between arms 700-855mm adjustable base width 420mm back height		
BRAND			MAX USER WEIGHT		
Oakwood			120kg		
SUPPLIER PRODUCT ID	JDE#	HEIGHT	PRICE BREAK	ORDERING CODE	
508	762030	Swivel bather	\$250-\$500	S5	
508/HA50	762021	Swivel bather with 50mm height adaptor	\$250-\$500	S5-50	
508/HA100	762013	Swivel bather with 100mm height adaptor	\$250-\$500	S5-100	

Swivel Bather				Band 1	
			SPECIFICATIONS		
			Swivel bather See below for height options		
SUPPLIER			DIMENSIONS		
Cubro			480mm width between arms 710mm width over bath		
BRAND			MAX USER WEIGHT		
Myco			100kg		
SUPPLIER PRODUCT ID	JDE#	HEIGHT	PRICE BREAK	ORDERING CODE	
502	765193	Swivel Bather with 25mm Height Adaptor	\$250-\$500	S17-25	
502/HA75	773759	Swivel Bather with 75mm Height Adaptor	\$250-\$500	S17-75	
502/HA150	773767	Swivel Bather with 150mm Height Adaptor	\$250-\$500	S17-150	

MINISTRY OF HEALTH BAND 1 LIST EQUIPMENT

SHOWER & BATH



Shower Stool		Band 1	
 		SPECIFICATIONS Shower stool without arms	
SUPPLIER		DIMENSIONS	
Goldfern Mobility		490-610mm adjustable height 285x380mm seat size	
BRAND		MAX USER WEIGHT	
Goldfern Mobility		120kg	
SUPPLIER PRODUCT ID	JDE#	PRICE BREAK	ORDERING CODE
GM-HMP-792	833150	\$50-\$250	S8-NA



Shower Stool		Band 1	
 		SPECIFICATIONS Shower stool with arms	
SUPPLIER		DIMENSIONS	
Goldfern Mobility		470mm width between arms 490-610mm adjustable height	
BRAND		MAX USER WEIGHT	
Goldfern Mobility		120kg	
SUPPLIER PRODUCT ID	JDE#	PRICE BREAK	ORDERING CODE
GM-HMP-792A	833168	\$50-\$250	S8-A



Shower Chair		Band 1	
		SPECIFICATIONS Shower chair without arms	
SUPPLIER		DIMENSIONS	
Goldfern Mobility		490-640mm adjustable height	
BRAND		MAX USER WEIGHT	
Goldfern Mobility		110kg	
SUPPLIER PRODUCT ID	JDE#	PRICE BREAK	ORDERING CODE
GM-HMP-792L	833272	\$50-\$250	S10-NA

MINISTRY OF HEALTH BAND 1 LIST EQUIPMENT

SHOWER & BATH

Shower Chair		Band 1	
 		SPECIFICATIONS	
		Shower chair with arms	
SUPPLIER		DIMENSIONS	
Goldfern Mobility		490mm width between arms 490-640mm adjustable height	
BRAND		MAX USER WEIGHT	
Goldfern Mobility		110kg	
SUPPLIER PRODUCT ID	JDE#	PRICE BREAK	ORDERING CODE
GM-HMP-792LA	833281	\$50-\$250	S10-A

Shower Chair		Band 1	
 		SPECIFICATIONS	
		Shower chair maxi with arms	
SUPPLIER		DIMENSIONS	
Cubro		500mm width between arms 420-550mm adjustable height	
BRAND		MAX USER WEIGHT	
Viking		200kg	
SUPPLIER PRODUCT ID	JDE#	PRICE BREAK	ORDERING CODE
336M500	740981	\$50-\$250	S19-A

Shower Commode Chair		Band 1	
 		SPECIFICATIONS	
		Closed seat Bariatric	
SUPPLIER		DIMENSIONS	
Allied Medical Ltd		430-580mm adjustable height 610mm seat width 430mm seat depth	
BRAND		MAX USER WEIGHT	
Drive		280kg	
SUPPLIER PRODUCT ID	JDE#	PRICE BREAK	ORDERING CODE
DM190	834371	\$500-\$750	BA24

© All contents within this document are the copyrighted property of Enable New Zealand. Contents may not be copied, reproduced, modified, published, uploaded, posted, transmitted or distributed in any way without the prior written consent of Enable New Zealand.

MINISTRY OF HEALTH BAND 1 LIST EQUIPMENT

SHOWER & BATH



Shower Commode		Band 1	
		SPECIFICATIONS	
		Transit wheels Soft seat with keyhole opening Adjustable seat height Adjustable leg rests Pan with lid and carrier included	
SUPPLIER		DIMENSIONS	
Invacare New Zealand		480mm seat width 450mm seat depth	
BRAND		MAX USER WEIGHT	
Aquatec		150kg	
SUPPLIER PRODUCT ID	JDE#	PRICE BREAK	ORDERING CODE
PKG-1564775	834363	\$500-\$750	S110



Shower Commode		Band 1	
		SPECIFICATIONS	
		Self-propelling Seat options below	
SUPPLIER		DIMENSIONS	
Cubro		430mm seat width 430mm seat depth	
BRAND		MAX USER WEIGHT	
Viking II		160kg	
SUPPLIER PRODUCT ID	JDE#	PRICE BREAK	ORDERING CODE
2348U	853951	Over \$1000	S12

Accessories				
DESCRIPTION	JDE#	SUPPLIER PRODUCT ID	PRICE BREAK	ORDERING CODE
Closed seat	840747	75PC	\$50-\$250	PA29
Open seat	833660	75PO	\$50-\$250	PA22
Pan and carrier	840499	2359/75P	\$50-\$250	PA23
Bowl with lid and carrier	840501	2359/325	\$50-\$250	PA24

MINISTRY OF HEALTH BAND 1 LIST EQUIPMENT

TOILETING

Toilet Seat		Band 1		
 		SPECIFICATIONS Raised toilet seat		
SUPPLIER		DIMENSIONS		
Permobil		385mm depth 350mm width		
BRAND		MAX USER WEIGHT		
Patterson's		190kg		
SUPPLIER PRODUCT ID	JDE#	HEIGHT	PRICE BREAK	ORDERING CODE
TE300	759834	50mm	\$50-\$250	T5-50
TE302	759851	100mm	\$50-\$250	T5-100

Toilet Seat		Band 1		
 		SPECIFICATIONS Raised toilet seat		
SUPPLIER		DIMENSIONS		
Cubro		390mm depth 360mm width		
BRAND		MAX USER WEIGHT		
ETAC		150kg		
SUPPLIER PRODUCT ID	JDE#	HEIGHT	PRICE BREAK	ORDERING CODE
5450	760000	60mm	\$50-\$250	T8-60
5451	759990	100mm	\$50-\$250	T8-100

MINISTRY OF HEALTH BAND 1 LIST EQUIPMENT

TOILETING



Toilet Seat		Band 1	
		SPECIFICATIONS Raised toilet seat 150mm	
SUPPLIER		DIMENSIONS	
Allied Medical Ltd		360mm width 410mm depth 150mm height	
BRAND		MAX USER WEIGHT	
Drive		200kg	
SUPPLIER PRODUCT ID	JDE#	PRICE BREAK	ORDERING CODE
DM12066	834072	\$50-\$250	T8-150



Toilet Surround		Band 1	
		SPECIFICATIONS Freestanding toilet frame	
SUPPLIER		DIMENSIONS	
Goldfern Mobility		440-640mm adjustable width	
BRAND		MAX USER WEIGHT	
Goldfern Mobility		120kg	
SUPPLIER PRODUCT ID	JDE#	PRICE BREAK	ORDERING CODE
GM-HMP-8109	872634	\$50-\$250	T4



Toilet Surround		Band 1	
		SPECIFICATIONS Toilet surround	
SUPPLIER		DIMENSIONS	
Cubro		650-750mm adjustable floor- arm height 450-550mm between arm width	
BRAND		MAX USER WEIGHT	
Oakwood		100kg	
SUPPLIER PRODUCT ID	JDE#	PRICE BREAK	ORDERING CODE
228	773732	\$50-\$250	T10

MINISTRY OF HEALTH BAND 1 LIST EQUIPMENT

TOILETING

Toilet Frame		Band 1	
 		SPECIFICATIONS Over-toilet frame Supplied with splash guard	
SUPPLIER		DIMENSIONS	
Cubro		480-620mm adjustable height 445mm between arm width	
BRAND		MAX USER WEIGHT	
Viking		150kg	
SUPPLIER PRODUCT ID	JDE#	PRICE BREAK	ORDERING CODE
390	753379	\$50-\$250	T3

Commode		Band 1	
 		SPECIFICATIONS 3 in 1 commode	
SUPPLIER		DIMENSIONS	
Permobil		580mm overall length 450mm overall width 430mm overall depth 405-560mm adjustable height	
BRAND		MAX USER WEIGHT	
Maxhealth		113kg	
SUPPLIER PRODUCT ID	JDE#	PRICE BREAK	ORDERING CODE
BC110	834380	\$50-\$250	T2

Commode		Band 1	
 		SPECIFICATIONS Bedside commode	
SUPPLIER		DIMENSIONS	
Cubro		480-600mm adjustable seat height 440mm seat width 440mm seat depth	
BRAND		MAX USER WEIGHT	
Viking		120kg	
SUPPLIER PRODUCT ID	JDE#	PRICE BREAK	ORDERING CODE
565	741221	\$50-\$250	T1

© All contents within this document are the copyrighted property of Enable New Zealand. Contents may not be copied, reproduced, modified, published, uploaded, posted, transmitted or distributed in any way without the prior written consent of Enable New Zealand.

MINISTRY OF HEALTH BAND 1 LIST EQUIPMENT

WHEELCHAIRS & SEATING

Cushion					Band 1
			SPECIFICATIONS		
			Komfit cushion with cover		
SUPPLIER			DIMENSIONS		
Permobil					
BRAND			MAX USER WEIGHT		
Permobil			95kg		
SUPPLIER PRODUCT ID	JDE#	SIZE	PRICE BREAK	ORDERING CODE	
CU500	747825	14x14"	\$50-\$250	CU17	
CU502	747876	16x16"	\$50-\$250	CU18	
CU503	747841	16x18"	\$50-\$250	CU19	
CU504	747850	18x16"	\$50-\$250	CU20	
CU505	747884	18x18"	\$50-\$250	CU21	

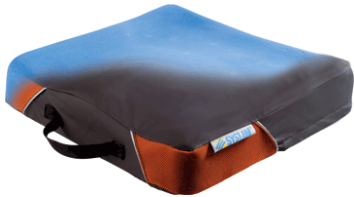
Cushion					Band 1
			SPECIFICATIONS		
			System France cushion		
SUPPLIER			DIMENSIONS		
Morton & Perry					
BRAND					
System France					
SUPPLIER PRODUCT ID	JDE#	SIZE	MAX USER WEIGHT	PRICE BREAK	ORDERING CODE
P371CS	834081	14x16"	90kg	\$50-\$250	CU22
P371C	834099	16x16"	100kg	\$50-\$250	CU24
P371CA	834101	16x18"	110kg	\$50-\$250	CU26
P371CL	834110	18x16"	110kg	\$50-\$250	CU28
P371L	834128	18x18"	130kg	\$50-\$250	CU30
P371XL	834136	20x18"	150kg	\$50-\$250	CU32

MINISTRY OF HEALTH BAND 1 LIST EQUIPMENT

WHEELCHAIRS & SEATING

Cushion Cover				Band 1
		SPECIFICATIONS		
		Systemam France replacement cover		
SUPPLIER		DIMENSIONS		
Morton & Perry				
BRAND		MAX USER WEIGHT		
Systemam France		N/A		
SUPPLIER PRODUCT ID	JDE#	SIZE	PRICE BREAK	ORDERING CODE
P371CSC	834144	14x16"	\$50-\$250	CU22C
P371CC	834152	16x16"	\$50-\$250	CU24C
P371CAC	834161	16x18"	\$50-\$250	CU26C
P371CLC	834179	18x16"	\$50-\$250	CU28C
P371LC	834187	18x18"	\$50-\$250	CU30C
P371XLC	834195	20x18"	\$50-\$250	CU32C

Cushion				Band 1
		SPECIFICATIONS		
		Reflex cushion with cover		
SUPPLIER		DIMENSIONS		
Allied Medical Ltd				
BRAND		MAX USER WEIGHT		
Varilite		295kg		
SUPPLIER PRODUCT ID	JDE#	SIZE	PRICE BREAK	ORDERING CODE
VL73500114162	751728	14x16"	\$50-\$250	CU6
VL73500116162	751736	16x16"	\$50-\$250	CU7
VL73500116182	751744	16x18"	\$50-\$250	CU8
VL73500118162	751752	18x16"	\$50-\$250	CU9
VL73500118182	751761	18x18"	\$50-\$250	CU10
VL73500118202	834208	18x20"	\$50-\$250	CU34
VL73500120182	751779	20x18"	\$50-\$250	CU11
VL73500120202	828570	20x20"	\$50-\$250	CU36

MINISTRY OF HEALTH BAND 1 LIST EQUIPMENT

WHEELCHAIRS & SEATING

Cushion Cover					Band 1
			SPECIFICATIONS		
			Reflex cushion cover replacement		
SUPPLIER			DIMENSIONS		
Allied Medical Ltd					
BRAND			MAX USER WEIGHT		
Varilite			N/A		
SUPPLIER PRODUCT ID	JDE#	SIZE	PRICE BREAK	ORDERING CODE	
VL05537	773265	14x16"	\$50-\$250	CU6C	
VL05543	773273	16x16"	\$50-\$250	CU7C	
VL05544	773281	16x18"	\$50-\$250	CU8C	
VL05547	773290	18x16"	\$50-\$250	CU9C	
VL05548	773302	18x18"	\$50-\$250	CU10C	
VL05549	834216	18x20"	\$50-\$250	CU34C	
VL05550	773311	20x18"	\$50-\$250	CU11C	
VL05551	834224	20x20"	\$50-\$250	CU36C	

Cushion					Band 1
			SPECIFICATIONS		
			AirLite cushion with cover		
SUPPLIER			DIMENSIONS		
Permobil					
BRAND			MAX USER WEIGHT		
ROHO			125kg		
SUPPLIER PRODUCT ID	JDE#	SIZE	PRICE BREAK	ORDERING CODE	
CU4372	749118	16x16"	\$50-\$250	CU1	
CU4373	749126	16x18"	\$50-\$250	CU2	
CU4378	749142	18x16"	\$50-\$250	CU3	
CU4379	749151	18x18"	\$50-\$250	CU4	
CU4382	749169	20x18"	\$50-\$250	CU5	

MINISTRY OF HEALTH BAND 1 LIST EQUIPMENT

WHEELCHAIRS & SEATING

Cushion Cover					Band 1
			SPECIFICATIONS		
			AirLite cushion replacement cover		
SUPPLIER			DIMENSIONS		
Permobil					
BRAND			MAX USER WEIGHT		
ROHO			N/A		
SUPPLIER PRODUCT ID	JDE#	SIZE	PRICE BREAK	ORDERING CODE	
CA4403	742531	16x16"	\$50-\$250	CU1C	
CA4404	742549	16x18"	\$50-\$250	CU2C	
CA4408	742565	18x16"	\$50-\$250	CU3C	
CA4409	742573	18x18"	\$50-\$250	CU4C	
CA4410	742581	20x18"	\$50-\$250	CU5C	

Wheelchair Manual					Band 1
			SPECIFICATIONS		
			Transit wheelchair Swing in/away and hieght adjustable footrests Anti-tippers Adjustable and removable arms		
SUPPLIER			DIMENSIONS		
Goldfern Mobility					
BRAND			MAX USER WEIGHT		
Goldfern Mobility			127kg		
SUPPLIER PRODUCT ID	JDE#	SIZE	PRICE BREAK	ORDERING CODE	
GME-AST-EUT1616	856141	16x16"	\$500-\$750	WC77	
GME-AST-EUT1818	856159	18x18"	\$500-\$750	WC78	
Accessories					
DESCRIPTION	JDE#	SUPPLIER PRODUCT ID	PRICE BREAK	ORDERING CODE	
Elevating leg rest - left	856204	GME-AST-EUELR-L	\$50-\$250	WC254	
Elevating leg rest - right	856212	GME-AST-EUELR-R	\$50-\$250	WC253	
Stump Support - left	856221	GME-AST-EUSS-L	\$50-\$250	WC252	
Stump Support - right	856239	GME-AST-EUSS-R	\$50-\$250	WC251	

MINISTRY OF HEALTH BAND 1 LIST EQUIPMENT

WHEELCHAIRS & SEATING

Wheelchair Manual Band 1

	SPECIFICATIONS
	Self propelling wheelchair Swing in/away and height adjustable footrests Anti-tippers Adjustable and removable arms

SUPPLIER	DIMENSIONS
Goldfern Mobility	

BRAND	MAX USER WEIGHT
Goldfern Mobility	127kg

SUPPLIER PRODUCT ID	JDE#	SIZE	PRICE BREAK	ORDERING CODE
GME-AST-EUSP1616	856124	16x16"	\$500-\$750	WC75
GME-AST-EUSP1818	856132	18x18"	\$500-\$750	WC76

Accessories

DESCRIPTION	JDE#	SUPPLIER PRODUCT ID	PRICE BREAK	ORDERING CODE
Elevating leg rest - left	856204	GME-AST-EUELR-L	\$50-\$250	WC254
Elevating leg rest - right	856212	GME-AST-EUELR-R	\$50-\$250	WC253
Stump Support - left	856221	GME-AST-EUSS-L	\$50-\$250	WC252
Stump Support - right	856239	GME-AST-EUSS-R	\$50-\$250	WC251

Ramp Band 1

	SPECIFICATIONS
	Aluminium ramp with non-skid surface

SUPPLIER	DIMENSIONS
Cubro	

BRAND	MAX USER WEIGHT
EuroRamps	267kg

SUPPLIER PRODUCT ID	JDE#	SIZE	PRICE BREAK	ORDERING CODE
547	761117	25mm H x 125mm L x 850mm W	\$50-\$250	RA14
548	761301	50mm H x 250mm L x 850mm W	\$50-\$250	RA171
549	761310	75mm H x 375mm L x 850mm W	\$50-\$250	RA172

MINISTRY OF HEALTH BAND 1 LIST EQUIPMENT

PRODUCTS UNDER \$50

Equipment under the value of \$50 (GST inc) will not be provided unless:

- the person is living in residential care is under 65 or who has a lifelong disability.
- the person is unable to pay due to hardship and is receiving either a Special Benefit or Temporary Additional Support from Work and Income. Written confirmation from Work and Income is required to support the application.
- the person is under 16 years old.

NB – all relevant eligibility criteria must also be met.

Elbow Crutch		Band 1	
		SPECIFICATIONS	
		Junior forearm crutch Height adjustable	
SUPPLIER		DIMENSIONS	
Invacare New Zealand		460-690mm adjustable height	
BRAND		MAX USER WEIGHT	
Forearm std Junior		100kg	
SUPPLIER PRODUCT ID	JDE#	PRICE BREAK	ORDERING CODE
HE10344100	790381	Under \$50	P35

Elbow Crutch		Band 1		
		SPECIFICATIONS		
		Double adjustable - anatomical grip		
SUPPLIER		DIMENSIONS		
Goldfern Mobility		250-326mm adjustable height armband to grip 770-1000mm adjustable height handgrip to ground 1020-1326mm overall adjustable height		
BRAND		MAX USER WEIGHT		
Goldfern Mobility		127kg		
SUPPLIER PRODUCT ID	Description	JDE#	PRICE BREAK	ORDERING CODE
GM-TKMQP35ML	Left	833547	Under \$50	C5L
GM-TKMQP35MR	Right	833555	Under \$50	C5R

MINISTRY OF HEALTH BAND 1 LIST EQUIPMENT

PRODUCTS UNDER \$50

Equipment under the value of \$50 (GST inc) will not be provided unless:

- the person is living in residential care is under 65 or who has a lifelong disability.
- the person is unable to pay due to hardship and is receiving either a Special Benefit or Temporary Additional Support from Work and Income. Written confirmation from Work and Income is required to support the application.
- the person is under 16 years old.

NB – all relevant eligibility criteria must also be met.

Elbow Crutch		Band 1	
		SPECIFICATIONS	
		Double adjustable	
SUPPLIER		DIMENSIONS	
Goldfern Mobility		250-326mm adjustable height armband to grip 770-1000mm adjustable height handgrip to ground 1020-1326mm overall adjustable height	
BRAND		MAX USER WEIGHT	
Goldfern Mobility		125kg	
SUPPLIER PRODUCT ID	JDE#	PRICE BREAK	ORDERING CODE
GM-TK856M	833563	Under \$50	C14

Quad Stick			Band 1		
			SPECIFICATIONS		
			Four point / pronged base Swan neck		
SUPPLIER			DIMENSIONS		
Allied Medical Ltd			730-960mm Adjustable height		
BRAND			MAX USER WEIGHT		
Allied Medical Ltd			110kg		
SUPPLIER PRODUCT ID	JDE#	SIZE	BASE	PRICE BREAK	ORDERING CODE
MP10501K	773679	Small	127x178mm	Under \$50	Q2
MP10502K	773661	Large	178x279mm	Under \$50	Q1

MINISTRY OF HEALTH BAND 1 LIST EQUIPMENT

PRODUCTS UNDER \$50

Equipment under the value of \$50 (GST inc) will not be provided unless:

- the person is living in residential care is under 65 or who has a lifelong disability.
- the person is unable to pay due to hardship and is receiving either a Special Benefit or Temporary Additional Support from Work and Income. Written confirmation from Work and Income is required to support the application.
- the person is under 16 years old.

NB – all relevant eligibility criteria must also be met.

Walking Stick		Band 1	
		SPECIFICATIONS	
		Swan neck	
SUPPLIER		DIMENSIONS	
Cubro		760-995mm adjustable height	
BRAND		MAX USER WEIGHT	
Swan		127kg	
SUPPLIER PRODUCT ID	JDE#	PRICE BREAK	ORDERING CODE
1706	766840	Under \$50	WS1

Walking Stick		Band 1	
		SPECIFICATIONS	
		Crook handle	
SUPPLIER		DIMENSIONS	
Cubro		760-995mm adjustable height	
BRAND		MAX USER WEIGHT	
Crook		127kg	
SUPPLIER PRODUCT ID	JDE#	PRICE BREAK	ORDERING CODE
1704BL	766591	Under \$50	WS2

MINISTRY OF HEALTH BAND 1 LIST EQUIPMENT

PRODUCTS UNDER \$50

Equipment under the value of \$50 (GST inc) will not be provided unless:

- the person is living in residential care is under 65 or who has a lifelong disability.
- the person is unable to pay due to hardship and is receiving either a Special Benefit or Temporary Additional Support from Work and Income. Written confirmation from Work and Income is required to support the application.
- the person is under 16 years old.

NB – all relevant eligibility criteria must also be met.

Walking Stick		Band 1	
		SPECIFICATIONS	
		Crook handle - contour foot	
SUPPLIER		DIMENSIONS	
Cubro		760-995mm adjustable height	
BRAND		MAX USER WEIGHT	
Crook / Contour Foot		127kg	
SUPPLIER PRODUCT ID	JDE#	PRICE BREAK	ORDERING CODE
1704BL/1757	773644	Under \$50	WS3

Walking Stick		Band 1	
		SPECIFICATIONS	
		Swan neck - contour foot	
SUPPLIER		DIMENSIONS	
Cubro		760-995mm adjustable height	
BRAND		MAX USER WEIGHT	
Swan / Contour foot		127kg	
SUPPLIER PRODUCT ID	JDE#	PRICE BREAK	ORDERING CODE
1706/1757	773652	Under \$50	WS4

MINISTRY OF HEALTH BAND 1 LIST EQUIPMENT

PRODUCTS UNDER \$50

Equipment under the value of \$50 (GST inc) will not be provided unless:

- the person is living in residential care is under 65 or who has a lifelong disability.
- the person is unable to pay due to hardship and is receiving either a Special Benefit or Temporary Additional Support from Work and Income. Written confirmation from Work and Income is required to support the application.
- the person is under 16 years old.

NB – all relevant eligibility criteria must also be met.

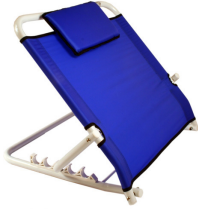
Backrest		Band 1	
		SPECIFICATIONS	
		Manual option Webbed back rest	
SUPPLIER		DIMENSIONS	
Invacare New Zealand			
BRAND		MAX USER WEIGHT	
		N/A	
SUPPLIER PRODUCT ID	JDE#	PRICE BREAK	ORDERING CODE
HE10780020	736860	Under \$50	B8

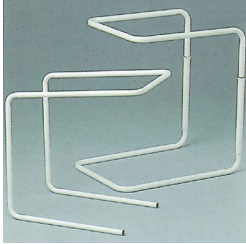
Bed Cradle		Band 1	
		SPECIFICATIONS	
		Bed cradle	
SUPPLIER		DIMENSIONS	
Cubro		600mm height 500mm length 320mm width	
BRAND		MAX USER WEIGHT	
Viking		N/A	
SUPPLIER PRODUCT ID	JDE#	PRICE BREAK	ORDERING CODE
283	738881	Under \$50	B6

MINISTRY OF HEALTH BAND 1 LIST EQUIPMENT

PRODUCTS UNDER \$50

Equipment under the value of \$50 (GST inc) will not be provided unless:

- the person is living in residential care is under 65 or who has a lifelong disability.
- the person is unable to pay due to hardship and is receiving either a Special Benefit or Temporary Additional Support from Work and Income. Written confirmation from Work and Income is required to support the application.
- the person is under 16 years old.

NB – all relevant eligibility criteria must also be met.

Mug		Band 1	
		SPECIFICATIONS	
		Clear caring mug	
SUPPLIER		DIMENSIONS	
Permobil		300ml	
BRAND		MAX USER WEIGHT	
		N/A	
SUPPLIER PRODUCT ID	JDE#	PRICE BREAK	ORDERING CODE
AD3131	784773	Under \$50	K79

Mug		Band 1	
		SPECIFICATIONS	
		Drinker with non-return straw	
SUPPLIER		DIMENSIONS	
Permobil			
BRAND		MAX USER WEIGHT	
Neater		N/A	
SUPPLIER PRODUCT ID	JDE#	PRICE BREAK	ORDERING CODE
AD228	812228	Under \$50	K80

MINISTRY OF HEALTH BAND 1 LIST EQUIPMENT

PRODUCTS UNDER \$50

Equipment under the value of \$50 (GST inc) will not be provided unless:

- the person is living in residential care is under 65 or who has a lifelong disability.
- the person is unable to pay due to hardship and is receiving either a Special Benefit or Temporary Additional Support from Work and Income. Written confirmation from Work and Income is required to support the application.
- the person is under 16 years old.

NB – all relevant eligibility criteria must also be met.

Mug		Band 1	
		SPECIFICATIONS	
		Lightweight insulated with lid	
SUPPLIER		DIMENSIONS	
Permobil		12oz	
BRAND		MAX USER WEIGHT	
Neater		N/A	
SUPPLIER PRODUCT ID	JDE#	PRICE BREAK	ORDERING CODE
AD3003	777371	Under \$50	K81

Cutlery		Band 1	
		SPECIFICATIONS	
		Supergrip bendable set of 4	
SUPPLIER		DIMENSIONS	
Permobil			
BRAND		MAX USER WEIGHT	
Supergrip		N/A	
SUPPLIER PRODUCT ID	JDE#	PRICE BREAK	ORDERING CODE
AD3216	766399	Under \$50	K82

MINISTRY OF HEALTH BAND 1 LIST EQUIPMENT

PRODUCTS UNDER \$50

Equipment under the value of \$50 (GST inc) will not be provided unless:

- the person is living in residential care is under 65 or who has a lifelong disability.
- the person is unable to pay due to hardship and is receiving either a Special Benefit or Temporary Additional Support from Work and Income. Written confirmation from Work and Income is required to support the application.
- the person is under 16 years old.

NB – all relevant eligibility criteria must also be met.



Plate		Band 1	
		SPECIFICATIONS	
		Temuka	
SUPPLIER		DIMENSIONS	
Permobil		20cm diameter	
BRAND		MAX USER WEIGHT	
		N/A	
SUPPLIER PRODUCT ID	JDE#	PRICE BREAK	ORDERING CODE
KC400	784802	Under \$50	K83

Plate		Band 1	
		SPECIFICATIONS	
		Hi-Lo scoop	
SUPPLIER		DIMENSIONS	
Permobil		20cm diameter 4cm vertical walls	
BRAND		MAX USER WEIGHT	
		N/A	
SUPPLIER PRODUCT ID	JDE#	PRICE BREAK	ORDERING CODE
AD3002	777338	Under \$50	K84

MINISTRY OF HEALTH BAND 1 LIST EQUIPMENT

PRODUCTS UNDER \$50

Equipment under the value of \$50 (GST inc) will not be provided unless:

- the person is living in residential care is under 65 or who has a lifelong disability.
- the person is unable to pay due to hardship and is receiving either a Special Benefit or Temporary Additional Support from Work and Income. Written confirmation from Work and Income is required to support the application.
- the person is under 16 years old.

NB – all relevant eligibility criteria must also be met.

Plate					Band 1
			SPECIFICATIONS		
			Manoy		
SUPPLIER			DIMENSIONS		
Permobil					
BRAND			MAX USER WEIGHT		
			N/A		
SUPPLIER PRODUCT ID	JDE#	SIZE	PRICE BREAK	ORDERING CODE	
AD3127	805204	Small	Under \$50	K85	
AD3126	777389	Large	Under \$50	K86	

Reacher					Band 1
			SPECIFICATIONS		
			Reacher Magnetic tip		
SUPPLIER			DIMENSIONS		
Permobil					
BRAND			MAX USER WEIGHT		
			N/A		
SUPPLIER PRODUCT ID	JDE#	LENGTH	PRICE BREAK	ORDERING CODE	
AR101	761336	600mm	Under \$50	K10-26	
AR100	761344	700mm	Under \$50	K10-32	

MINISTRY OF HEALTH BAND 1 LIST EQUIPMENT

PRODUCTS UNDER \$50

Equipment under the value of \$50 (GST inc) will not be provided unless:

- the person is living in residential care is under 65 or who has a lifelong disability.
- the person is unable to pay due to hardship and is receiving either a Special Benefit or Temporary Additional Support from Work and Income. Written confirmation from Work and Income is required to support the application.
- the person is under 16 years old.

NB – all relevant eligibility criteria must also be met.

Heel Protector		Band 1	
		SPECIFICATIONS	
		To provide skin protection for heels	
SUPPLIER		DIMENSIONS	
Cubro			
BRAND		MAX USER WEIGHT	
Softech		N/A	
SUPPLIER PRODUCT ID	JDE#	PRICE BREAK	ORDERING CODE
178	755454	Under \$50	B23

Slide Sheet		Band 1	
		SPECIFICATIONS	
		Transfer sheet Polyester	
SUPPLIER		DIMENSIONS	
Multifit Hospital Supplies LTD		1x1.5m	
BRAND		MAX USER WEIGHT	
		N/A	
SUPPLIER PRODUCT ID	JDE#	PRICE BREAK	ORDERING CODE
MF SS_AMS 1	834291	Under \$50	TB69

MINISTRY OF HEALTH BAND 1 LIST EQUIPMENT

PRODUCTS UNDER \$50

Equipment under the value of \$50 (GST inc) will not be provided unless:

- the person is living in residential care is under 65 or who has a lifelong disability.
- the person is unable to pay due to hardship and is receiving either a Special Benefit or Temporary Additional Support from Work and Income. Written confirmation from Work and Income is required to support the application.
- the person is under 16 years old.

NB – all relevant eligibility criteria must also be met.

Urinal		Band 1	
		SPECIFICATIONS	
		Male non-spill urinal High quality plastic urinal bottle with easy to hold handle Autoclaveable to 135°C	
SUPPLIER		DIMENSIONS	
Cubro		500ml capacity	
BRAND		MAX USER WEIGHT	
Plaspro		N/A	
SUPPLIER PRODUCT ID	JDE#	PRICE BREAK	ORDERING CODE
212	766372	Under \$50	T6

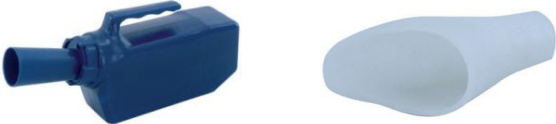
Urinal		Band 1	
		SPECIFICATIONS	
		Female non-spill urinal High quality plastic urinal bottle with easy to hold handle Autoclaveable to 135°C	
SUPPLIER		DIMENSIONS	
Cubro		500ml capacity	
BRAND		MAX USER WEIGHT	
Plaspro		N/A	
SUPPLIER PRODUCT ID	JDE#	PRICE BREAK	ORDERING CODE
212/D	766364	Under \$50	T6-F

Enable

NEW ZEALAND[®]



MINISTRY OF HEALTH

LIST EQUIPMENT BAND 2 & 3

TABLE OF CONTENTS

REHABILITATION EQUIPMENT	PAGE NUMBER
AMBULATORY MOBILITY	61
BEDROOM	65
KITCHEN & LIVING	72
PATIENT LIFTERS	73
SHOWER & BATH	80
TOILETING	84
WHEELCHAIR & SEATING	85

MINISTRY OF HEALTH BAND 2 & 3 LIST EQUIPMENT

AMBULATORY MOBILITY

Crutches		Band 2	
		SPECIFICATIONS	
		Each Bariatric	
SUPPLIER		DIMENSIONS	
Tubular Equipment		980 - 1230mm adjustable height 175x125mm trough dimension	
BRAND		MAX USER WEIGHT	
Tubular Equipment		250kg	
SUPPLIER PRODUCT ID	JDE#	PRICE BREAK	ORDERING CODE
GCHD8	834419	\$50-\$250	BA9

Walking Frame		Band 2		
		SPECIFICATIONS		
SUPPLIER		DIMENSIONS		
Tubular Equipment		400 - 560mm adjustable height 440mm width		
BRAND		MAX USER WEIGHT		
Tiny Tot		70kg		
SUPPLIER PRODUCT ID	JDE#	SPECIFICATIONS	PRICE BREAK	ORDERING CODE
TT1302G	766524	2 wheels, 2 glide feet	\$250-\$500	P42
TT1307C	746507	2 castors, 2 wheels	\$250-\$500	P41
Accessories				
DESCRIPTION	JDE#	SUPPLIER PRODUCT ID	PRICE BREAK	ORDERING CODE
Basket	841504	BSK 98	Under \$50	PA28

MINISTRY OF HEALTH BAND 2 & 3 LIST EQUIPMENT

AMBULATORY MOBILITY

Walking Frame Band 2

	SPECIFICATIONS			
SUPPLIER		DIMENSIONS		
Tubular Equipment		460 - 750mm adjustable height 390mm width inside back legs		
BRAND		MAX USER WEIGHT		
Junior Rover		100kg		

SUPPLIER PRODUCT ID	JDE#	SPECIFICATIONS	PRICE BREAK	ORDERING CODE
JR102G	808544	2 wheels, 2 glide feet	\$250-\$500	P37
JR107C	810644	2 castors, 2 wheels	\$250-\$500	P22

Accessories

DESCRIPTION	JDE#	SUPPLIER PRODUCT ID	PRICE BREAK	ORDERING CODE
Basket/Tray	830400	BSKT 88	\$50-\$250	PA26

Walking Frame Band 2

	SPECIFICATIONS					
	Mustang					
SUPPLIER			DIMENSIONS			
Euromedical Ltd						
BRAND						
R82 of Denmark						

SUPPLIER PRODUCT ID	JDE#	SIZE	CHEST PAD HEIGHT	MAX USER WEIGHT	PRICE BREAK	ORDERING CODE
R82-869011	832190	1	650mm	30kg	\$2500-\$3000	WF78
R82-869021	826494	2	800mm	40kg	\$2500-\$3000	WF79

MINISTRY OF HEALTH BAND 2 & 3 LIST EQUIPMENT

AMBULATORY MOBILITY

Standing Frame				Band 2			
				SPECIFICATIONS			
				Totstander			
SUPPLIER				DIMENSIONS			
Allied Medical Ltd				470 - 640mm chest pad height 450mm base width x 450mm base height			
BRAND				MAX USER WEIGHT			
Leckey				20kg			
SUPPLIER PRODUCT ID		JDE#		PRICE BREAK		ORDERING CODE	
OB414C82=11000-21		764369		\$2000-\$2500		P83	

Standing Frame				Band 3			
				SPECIFICATIONS			
				Freestanding			
SUPPLIER				DIMENSIONS			
Allied Medical Ltd							
BRAND							
Leckey							
SUPPLIER PRODUCT ID	JDE#	Size	CHEST PAD HEIGHT	BASE	MAX USER WEIGHT	PRICE BREAK	ORDERING CODE
OB414C82=21000-21	764220	1	526 - 851mm	650x650mm	60kg	\$3000-\$4000	P63
OB414C82=22000-09	764238	2	681 - 1100mm	750x750mm	80kg	\$4000-\$5000	P64
OB414C82=23000-09	764246	3	975 - 1425mm	750x750mm	90kg	\$4000-\$5000	P65

MINISTRY OF HEALTH BAND 2 & 3 LIST EQUIPMENT

AMBULATORY MOBILITY

Standing Frame				Band 2			
				SPECIFICATIONS			
				Toucan			
SUPPLIER				DIMENSIONS			
Euromedical Ltd							
BRAND							
R82 of Denmark							
SUPPLIER PRODUCT ID	JDE#	Size	WIDTH	ADJUSTABLE HEIGHT	MAX USER WEIGHT	PRICE BREAK	ORDERING CODE
R82-861001	788782	1	560mm	340 - 700mm	30kg	\$2500-\$3000	P58
R82-861002	802919	2	630mm	540 - 900mm	40kg	\$2500-\$3000	P59
R82-861003	808958	3	630mm	740 - 1100mm	50kg	\$2500-\$3000	P60
R82-861004	815023	4	700mm	910 - 1210mm	60kg	\$2500-\$3000	P61
R82-861005	835139	5	700mm	1110 - 1410mm	70kg	\$2500-\$3000	P84

MINISTRY OF HEALTH BAND 2 & 3 LIST EQUIPMENT

BEDROOM

Overbed Table		Band 2	
		SPECIFICATIONS	
		Tilt top Split Top	
SUPPLIER		DIMENSIONS	
Allied Medical Ltd		410x610mm top size 720-1150mm adjustable height	
BRAND		MAX USER WEIGHT	
Maxhealth		N/A	
SUPPLIER PRODUCT ID	JDE#	PRICE BREAK	ORDERING CODE
MP30203	828431	\$50-\$250	B29

MINISTRY OF HEALTH BAND 2 & 3 LIST EQUIPMENT

BEDROOM

Bed Electric (New) Band 2

		SPECIFICATIONS	
		Bed electric Trendelenberg See accessory options below	
SUPPLIER		DIMENSIONS	
Cubro		2000mm inside length 900mm inside width 390-800mm height adjustment	
BRAND		MAX SWL	MAX CLIENT WEIGHT
Bock Domiflex "Push and Ready"		190kg	155kg
SUPPLIER PRODUCT ID	JDE#	PRICE BREAK	ORDERING CODE
912/WAT	876221	\$1000-\$1500	B11

Accessories

DESCRIPTION	JDE#	SUPPLIER PRODUCT ID	SPECIFICATIONS	PRICE BREAK	ORDERING CODE
3/4 length side left	810177	910T-L	Folding	\$50-\$250	B13L
3/4 length side right	810185	910T-R	Folding	\$50-\$250	B13R
3/4 length side cover (each)	758381	PS910T	Vinyl padded	\$50-\$250	B16
Full length side left	876230	SRL912	Drop down	\$50-\$250	B264L
Full length side right	876248	SRR912	Drop down	\$50-\$250	B264R
Full length side cover (each)	786656	5115	Vinyl padded	\$50-\$250	B266
Extension kit 20cm	876256	EL912	Including bolster	\$50-\$250	B253
Full length sides cannot be used with the extension kit please use Extra Long Full length sides					
Extra long Full length side left	880010	SRL912EL	Drop down	\$50-\$250	B277L
Extra long Full length side right	880028	SRR912EL	Drop down	\$50-\$250	B277R
Self help pole	808317	5113		\$50-\$250	B14
Side Support Rail	841491	5109		\$50-\$250	B18

Mattress Band 2

		SPECIFICATIONS	
		Medi Flex Castellated Foam Mattress Single	
SUPPLIER		DIMENSIONS	
Cubro		1980x900x150mm	
BRAND		MAX USER WEIGHT	
MediFlex		N/A	
SUPPLIER PRODUCT ID	JDE#	PRICE BREAK	ORDERING CODE
1660	844326	\$250-\$500	B12

© All contents within this document are the copyrighted property of Enable New Zealand. Contents may not be copied, reproduced, modified, published, uploaded, posted, transmitted or distributed in any way without the prior written consent of Enable New Zealand.

MINISTRY OF HEALTH BAND 2 & 3 LIST EQUIPMENT

BEDROOM

Bed Electric Ultra Low Band 2

		SPECIFICATIONS	
		Bed electric ultra low Trendelenberg See accessory options below	
SUPPLIER		DIMENSIONS	
Cubro		2000mm inside length 900mm inside width 210-640mm height adjustment	
BRAND		MAX SWL	MAX CLIENT WEIGHT
Bock Domiflex Classic Ultra Low		170kg	135kg
SUPPLIER PRODUCT ID	JDE#	PRICE BREAK	ORDERING CODE
915/WA	857258	\$1000-\$1500	B274

Accessories

DESCRIPTION	JDE#	SUPPLIER PRODUCT ID	SPECIFICATIONS	PRICE BREAK	ORDERING CODE
3/4 length side left	810177	910T-L	Folding	\$50-\$250	B13L
3/4 length side right	810185	910T-R	Folding	\$50-\$250	B13R
3/4 length side cover (each)	758381	PS910T	Vinyl padded	\$50-\$250	B16
Full length side left	857266	SRL915	Drop down	\$50-\$250	B267L
Full length side right	857282	SRR915	Drop down	\$50-\$250	B267R
Full length side cover (each)	786656	5115	Vinyl padded	\$50-\$250	B266
Extension kit 20cm	801836	5066	Including bolster	\$50-\$250	B269
Full length sides cannot be used with the extension kit please use Extra Long Full length sides					
Extra long Full length side left	880052	SRL915EL	Drop down	\$50-\$250	B278L
Extra long Full length side right	880061	SRR915EL	Drop down	\$50-\$250	B278R
Self help pole	808317	5113		\$50-\$250	B14
Side Support Rail	841491	5109		\$50-\$250	B18

Mattress Band 2

		SPECIFICATIONS	
		Medi Flex Castellated Foam Mattress Single	
SUPPLIER		DIMENSIONS	
Cubro		1980x900x150mm	
BRAND		MAX USER WEIGHT	
MediFlex		N/A	
SUPPLIER PRODUCT ID	JDE#	PRICE BREAK	ORDERING CODE
1660	844326	\$250-\$500	B12

© All contents within this document are the copyrighted property of Enable New Zealand. Contents may not be copied, reproduced, modified, published, uploaded, posted, transmitted or distributed in any way without the prior written consent of Enable New Zealand.

MINISTRY OF HEALTH BAND 2 & 3 LIST EQUIPMENT

BEDROOM

Bed Electric King Single Band 3

		SPECIFICATIONS	
		Bed electric super single Trendelenberg See accessory options below	
SUPPLIER		DIMENSIONS	
Cubro		2000mm inside length 1100mm inside width 250-800mm height adjustment	
BRAND		MAX SWL	MAX CLIENT WEIGHT
Bock Practico Lie Low Extra Wide		220kg	185kg
SUPPLIER PRODUCT ID	JDE#	PRICE BREAK	ORDERING CODE
947/WA	867392	\$3000-\$4000	B275

Accessories

DESCRIPTION	JDE#	SUPPLIER PRODUCT ID	SPECIFICATIONS	PRICE BREAK	ORDERING CODE
3/4 length side left	810177	910T-L	Folding	\$50-\$250	B13L
3/4 length side right	810185	910T-R	Folding	\$50-\$250	B13R
3/4 length side cover (each)	758381	PS910T	Vinyl padded	\$50-\$250	B16
Full length side left	802231	SRL920	Drop down	\$50-\$250	B270L
Full length side right	802249	SRR920	Drop down	\$50-\$250	B270R
Full length side cover (each)	786656	5115	Vinyl padded	\$50-\$250	B266
Extension kit	846129	5067	Including mattress	\$50-\$250	B272
Full length sides cannot be used with the extension kit please use Extra Long Full length sides					
Extra long Full length side left	880079	SRL920EL	Drop down	\$50-\$250	B279L
Extra long Full length side right	880087	SRR920EL	Drop down	\$50-\$250	B279R
Self help pole	808317	5113		\$50-\$250	B14
Side Support Rail	841491	5109		\$50-\$250	B18

Mattress Band 2

		SPECIFICATIONS	
		Medi Flex Castellated Foam Mattress Super Single	
SUPPLIER		DIMENSIONS	
Cubro		1980x1100x150mm	
BRAND		MAX USER WEIGHT	
MediFlex		N/A	
SUPPLIER PRODUCT ID	JDE#	PRICE BREAK	ORDERING CODE
1661	852449	\$750-\$1000	B273

© All contents within this document are the copyrighted property of Enable New Zealand. Contents may not be copied, reproduced, modified, published, uploaded, posted, transmitted or distributed in any way without the prior written consent of Enable New Zealand.

MINISTRY OF HEALTH BAND 2 & 3 LIST EQUIPMENT

BEDROOM

Bed Electric Bariatric				Band 3	
			SPECIFICATIONS		
			Bed electric bariatric Trendelenberg See accessory options below (Note: Other bariatric bed sizes are available on request)		
SUPPLIER		DIMENSIONS			
Burmark		2000mm inside length 1200mm inside width 200-650mm height adjustment			
BRAND		MAX USER WEIGHT			
Burmark		300kg			
SUPPLIER PRODUCT ID	JDE#	PRICE BREAK	ORDERING CODE		
LH300-1200BT	874832	\$5000-\$6000	B262		
Accessories					
DESCRIPTION	JDE#	SUPPLIER PRODUCT ID	SPECIFICATIONS	PRICE BREAK	ORDERING CODE
Handle support	867114	Handle450_290	450x290mm	\$250-\$500	B260
Handle support	856968	Handle450_500	450x500mm	\$250-\$500	B256
Handle support	876281	Handle450_800	450x800mm	\$250-\$500	B261
Self help pole	851121	Liftpole_dual	Double Handle	\$500-\$750	B258

Mattress				Band 2	
			SPECIFICATIONS		
			Bariatric mattress foam		
SUPPLIER		DIMENSIONS			
Burmark		2000x1200x180mm			
BRAND		MAX USER WEIGHT			
Burmark		N/A			
SUPPLIER PRODUCT ID	JDE#	PRICE BREAK	ORDERING CODE		
Mat_2000-1200-180B	875456	\$1000-\$1500	B263		

MINISTRY OF HEALTH BAND 2 & 3 LIST EQUIPMENT

BEDROOM

Bed Electric Band 3

		SPECIFICATIONS	
		Paediatric ages 3-12 years Bed electric See accessory options below	
SUPPLIER		DIMENSIONS	
Invacare Ltd		Bed ends 700x400mm Mattress platform size 1600x700mm 300-850mm height adjustable	
BRAND		MAX USER WEIGHT	
ScanBeta		70kg	
SUPPLIER PRODUCT ID	JDE#	PRICE BREAK	ORDERING CODE
1555349-70160-SO	839931	\$3000-\$4000	B245

Accessories					
DESCRIPTION	JDE#	SUPPLIER PRODUCT ID	SPECIFICATIONS	PRICE BREAK	ORDERING CODE
Cotside (each) Lowering	839949	1554522-16040-01	1600x400mm	\$250-\$500	B246
Cotside (each) Centre Opening	840368	1553928-16040-S1	1600x400mm	\$250-\$500	B247

Mattress Band 2

		SPECIFICATIONS	
		Paediatric Mattress to suit ScanBeta bed	
SUPPLIER		DIMENSIONS	
Invacare Ltd		1600x700mm	
BRAND		MAX USER WEIGHT	
Junior Press		N/A	
SUPPLIER PRODUCT ID	JDE#	PRICE BREAK	ORDERING CODE
PRESSJNR160	840237	\$500-\$750	B248

MINISTRY OF HEALTH BAND 2 & 3 LIST EQUIPMENT

BEDROOM

Bed Electric Band 2

		SPECIFICATIONS	
		<p>Bed electric See accessory options below Suitable for Paediatric use</p> <p>when cotsides are required they must always be ordered as a pair due to safety issues.</p> <p>The configuration of this bed has high bed-ends designed specifically for the Mesh Cotsides. Standard cotsides will not fit.</p>	
SUPPLIER		DIMENSIONS	
Cubro		Mattress Platform size 2000x900mm 370-830mm height adjustable	
BRAND		MAX USER WEIGHT	
Bock Belluno		135kg	
SUPPLIER PRODUCT ID	JDE#	PRICE BREAK	ORDERING CODE
920/WA+5105	844334	\$2500-\$3000	B242

Accessories					
DESCRIPTION	JDE#	SUPPLIER PRODUCT ID	SPECIFICATIONS	PRICE BREAK	ORDERING CODE
Siderail Drop Down - Left	806418	5120	Mesh High Side	\$1000-\$1500	B243
Siderail Drop Down - Right	806426	5121	Mesh High Side	\$1000-\$1500	B244

Mattress Band 2

		SPECIFICATIONS	
		<p>Medi Flex Castellated Foam Mattress Single</p>	
SUPPLIER		DIMENSIONS	
Cubro		1980x900x150mm	
BRAND		MAX USER WEIGHT	
MediFlex		N/A	
SUPPLIER PRODUCT ID	JDE#	PRICE BREAK	ORDERING CODE
1660	844326	\$250-\$500	B12

MINISTRY OF HEALTH BAND 2 & 3 LIST EQUIPMENT

KITCHEN & LIVING

Chair		Band 2	
		SPECIFICATIONS	
		Rehab chair High back	
SUPPLIER		DIMENSIONS	
Cubro		400 - 550mm adjustable height 490mm width between arms 480 - 520mm adjustable seat depth	
BRAND		MAX USER WEIGHT	
Viking		200kg	
SUPPLIER PRODUCT ID	JDE#	PRICE BREAK	ORDERING CODE
626S	835008	\$250-\$500	K5-H

Lift Out Chair		Band 2	
		SPECIFICATIONS	
		Dual motor Rechargeable battery backup Removable back	
SUPPLIER		DIMENSIONS	
Goldfern Mobility		900mm overall width 440mm width between arms 530mm seat depth	
BRAND		MAX USER WEIGHT	
Goldfern Mobility		150kg	
SUPPLIER PRODUCT ID	JDE#	PRICE BREAK	ORDERING CODE
GM-HYE-8063	854815	\$750-\$1000	K30

MINISTRY OF HEALTH BAND 2 & 3 LIST EQUIPMENT

PATIENT LIFTERS

Hoist		Band 3	
		SPECIFICATIONS	
		Standing hoist	
SUPPLIER		DIMENSIONS	
Active Healthcare		1010mm overall height 900mm overall length 500mm overall width (closed) 430 - 580mm inner base width	
BRAND		MAX USER WEIGHT	
Minilift		125kg	
SUPPLIER PRODUCT ID	JDE#	PRICE BREAK	ORDERING CODE
0252-1003	776247	\$3000-\$4000	TB50

Hoist		Band 3	
		SPECIFICATIONS	
		Standing hoist	
SUPPLIER		DIMENSIONS	
Active Healthcare		1000mm overall height 980mm overall length 590mm overall width (closed) 450 - 875mm inner base width	
BRAND		MAX USER WEIGHT	
Minilift		200kg	
SUPPLIER PRODUCT ID	JDE#	PRICE BREAK	ORDERING CODE
0252-1004	874648	\$4000-\$5000	TB63

MINISTRY OF HEALTH BAND 2 & 3 LIST EQUIPMENT

PATIENT LIFTERS

Sling					Band 2
			SPECIFICATIONS		
			Standfast Fabric Loop For use with Minilift standing hoists		
SUPPLIER			DIMENSIONS		
Active Healthcare					
BRAND			MAX USER WEIGHT		
Smartlift			N/A		
SUPPLIER PRODUCT ID	JDE#	SIZE	PRICE BREAK	ORDERING CODE	
0253-1872	808368	Small	\$250-\$500	TB55	
0253-1873	801529	Medium	\$250-\$500	TB56	
0253-1874	800091	Large	\$250-\$500	TB57	
0253-1875	778058	X-large	\$250-\$500	TB58	

Sling					Band 2
			SPECIFICATIONS		
			Bliss Fabric Loop For use with Minilift standing hoists		
SUPPLIER			DIMENSIONS		
Active Healthcare					
BRAND			MAX USER WEIGHT		
Smartlift			N/A		
SUPPLIER PRODUCT ID	JDE#	SIZE	PRICE BREAK	ORDERING CODE	
0253-0899	834540	Small	\$250-\$500	TB51	
0253-0898	823630	Medium	\$250-\$500	TB52	
0253-0897	808106	Large	\$250-\$500	TB53	
0253-0900	828668	X-large	\$250-\$500	TB54	

MINISTRY OF HEALTH BAND 2 & 3 LIST EQUIPMENT

PATIENT LIFTERS

Hoist		Band 2		
		SPECIFICATIONS		
		Birdie Compact - Hoist frame only Please also select Pivot or Yoke attachment		
SUPPLIER		DIMENSIONS		
Invacare Ltd		550mm overall width closed (external) 460 - 890mm Internal width 1700mm turning radius		
BRAND		MAX USER WEIGHT		
Invacare		150kg		
SUPPLIER PRODUCT ID	JDE#	PRICE BREAK	ORDERING CODE	
3000513.D3B02-0125	876328	\$2500-\$3000	TB385	
Accessories				
DESCRIPTION	JDE#	SUPPLIER PRODUCT ID	PRICE BREAK	ORDERING CODE
Pivot Attachment	876344	Pivot	Cost included with hoist	TB386
Yoke Attachment	876352	Yoke	Cost included with hoist	TB387

Hoist		Band 2		
		SPECIFICATIONS		
		Birdie - Hoist frame only Please also select Pivot or Yoke attachment		
SUPPLIER		DIMENSIONS		
Invacare Ltd		680mm overall width closed (external) 580 - 1040mm Internal width 1400mm turning radius		
BRAND		MAX USER WEIGHT		
Invacare		180kg		
SUPPLIER PRODUCT ID	JDE#	PRICE BREAK	ORDERING CODE	
3000503.E3B00-0125	813491	\$2500-\$3000	TB388	
Accessories				
DESCRIPTION	JDE#	SUPPLIER PRODUCT ID	PRICE BREAK	ORDERING CODE
Pivot Attachment	876344	Pivot	Cost included with hoist	TB386
Yoke Attachment	876352	Yoke	Cost included with hoist	TB387

MINISTRY OF HEALTH BAND 2 & 3 LIST EQUIPMENT

PATIENT LIFTERS

Yoke Sling					Band 2
			SPECIFICATIONS		
			General purpose sling Head support Fabric For use with Birdie and Birdie Compact with yoke attachment hoists		
SUPPLIER			DIMENSIONS		
Invacare Ltd					
BRAND			MAX USER WEIGHT		
Invacare			N/A		
SUPPLIER PRODUCT ID	JDE#	SIZE	PRICE BREAK	ORDERING CODE	
17209	834460	X-small	\$250-\$500	TB39	
17247	808915	Small	\$250-\$500	TB40	
17067	800711	Medium	\$250-\$500	TB41	
17069	834478	Large	\$250-\$500	TB42	
17205	826398	X-large	\$250-\$500	TB43	

Yoke Sling Yoke Sling					Band 2
			SPECIFICATIONS		
			General purpose sling Head support Mesh For use with Birdie and Birdie Compact with yoke attachment hoists		
SUPPLIER			DIMENSIONS		
Invacare Ltd					
BRAND			MAX USER WEIGHT		
Invacare			N/A		
SUPPLIER PRODUCT ID	JDE#	SIZE	PRICE BREAK	ORDERING CODE	
17126	824683	Small	\$250-\$500	TB372	
17127	840114	Medium	\$250-\$500	TB373	
17128	826566	Large	\$250-\$500	TB374	

MINISTRY OF HEALTH BAND 2 & 3 LIST EQUIPMENT

PATIENT LIFTERS

Yoke Sling					Band 2
			SPECIFICATIONS		
			General purpose sling Head support Hygiene fabric For use with Birdie and Birdie Compact with yoke attachment hoists		
SUPPLIER			DIMENSIONS		
Invacare Ltd					
BRAND			MAX USER WEIGHT		
Invacare			N/A		
SUPPLIER PRODUCT ID	JDE#	SIZE	PRICE BREAK	ORDERING CODE	
17402	845417	Small/black	\$250-\$500	TB375	
17395	845476	Medium/red	\$250-\$500	TB376	
17396	811989	Large/yellow	\$250-\$500	TB377	
17403	845484	X-large/green	\$250-\$500	TB378	

Sling					Band 2
			SPECIFICATIONS		
			General purpose sling Head support Hygiene mesh For use with Birdie and Birdie Compact with yoke attachment hoists		
SUPPLIER			DIMENSIONS		
Invacare Ltd					
BRAND			MAX USER WEIGHT		
Invacare			N/A		
SUPPLIER PRODUCT ID	JDE#	SIZE	PRICE BREAK	ORDERING CODE	
17405	834451	X-small/white	\$250-\$500	TB33	
17406	808974	Small/black	\$250-\$500	TB34	
17358	808982	Medium/red	\$250-\$500	TB35	
17359	816069	Large/yellow	\$250-\$500	TB36	
17407	845492	X-large/green	\$250-\$500	TB379	

MINISTRY OF HEALTH BAND 2 & 3 LIST EQUIPMENT

PATIENT LIFTERS

Pivot Sling					Band 2
			SPECIFICATIONS		
			Pivot sling Fabric For use with the Birdie Compact with pivot attachment		
SUPPLIER			DIMENSIONS		
Invacare Ltd					
BRAND			MAX USER WEIGHT		
Invacare			N/A		
SUPPLIER PRODUCT ID	JDE#	SIZE	PRICE BREAK	ORDERING CODE	
17133	834515	Small	\$250-\$500	TB46	
17134	814346	Medium	\$250-\$500	TB47	
17135	834523	Large	\$250-\$500	TB48	
17136	834531	X-large	\$250-\$500	TB49	

Pivot Sling					Band 2
			SPECIFICATIONS		
			Pivot sling Mesh For use with the Birdie Compact with pivot attachment		
SUPPLIER			DIMENSIONS		
Invacare Ltd					
BRAND			MAX USER WEIGHT		
Invacare			N/A		
SUPPLIER PRODUCT ID	JDE#	SIZE	PRICE BREAK	ORDERING CODE	
17240	808991	X-small	\$250-\$500	TB380	
17241	806215	Small	\$250-\$500	TB381	
17242	809002	Medium	\$250-\$500	TB382	
17243	814371	Large	\$250-\$500	TB383	
17244	808131	X-large	\$250-\$500	TB384	

MINISTRY OF HEALTH BAND 2 & 3 LIST EQUIPMENT

PATIENT LIFTERS

Pivot Sling				Band 2	
			SPECIFICATIONS		
			Pivot sling Hygiene mesh For use with the Birdie Compact with pivot attachment		
SUPPLIER			DIMENSIONS		
Invacare Ltd					
BRAND			MAX USER WEIGHT		
Invacare			N/A		
SUPPLIER PRODUCT ID	JDE#	SIZE	PRICE BREAK	ORDERING CODE	
17392	813714	Medium	\$250-\$500	TB37	
17393	824456	Large	\$250-\$500	TB38	

MINISTRY OF HEALTH BAND 2 & 3 LIST EQUIPMENT

SHOWER & BATH

Bathchair / Bath Support				Band 2			
				SPECIFICATIONS			
				Manatee			
SUPPLIER				DIMENSIONS			
Euromedical Ltd				140-430mm adjustable seat height			
BRAND							
R82 of Denmark							
SUPPLIER PRODUCT ID	JDE#	SIZE	WIDTH	MAX USER WEIGHT	PRICE BREAK	ORDERING CODE	
R82-882005	786322	0	420mm	50kg	\$1000-\$1500	P43	
R82-882015	786314	1	420mm	50kg	\$1000-\$1500	P44	
R82-882025	777477	2	420mm	75kg	\$1000-\$1500	P45	
R82-882035	835180	3	490mm	75kg	\$1000-\$1500	P46	

Bathchair / Bath Support				Band 2			
				SPECIFICATIONS			
				Flamingo			
SUPPLIER				DIMENSIONS			
Euromedical Ltd							
BRAND							
R82 of Denmark							
SUPPLIER PRODUCT ID	JDE#	SIZE	SEAT WIDTH	OVERALL WIDTH	MAX USER WEIGHT	PRICE BREAK	ORDERING CODE
R82-880001	741351	1	250mm	440mm	33kg	\$2500-\$3000	P85
R82-880002	741360	2	280mm	460mm	50kg	\$2500-\$3000	P86
R82-880003	741378	3	320mm	500mm	60kg	\$2500-\$3000	P87
R82-880004	741386	4	340mm	540mm	70kg	\$2500-\$3000	P88

MINISTRY OF HEALTH BAND 2 & 3 LIST EQUIPMENT

SHOWER & BATH

Shower Stool		Band 2	
		SPECIFICATIONS	
		Without arms Bariatric	
SUPPLIER		DIMENSIONS	
Superquip Ltd		465 - 590mm adjustable height	
BRAND		MAX USER WEIGHT	
Superquip		250kg	
SUPPLIER PRODUCT ID	JDE#	PRICE BREAK	ORDERING CODE
056AM	765071	\$250-\$500	BA2

Shower Stool		Band 2	
		SPECIFICATIONS	
		With arms Bariatric	
SUPPLIER		DIMENSIONS	
Superquip Ltd		600mm width between arms 465 - 590mm adjustable height	
BRAND		MAX USER WEIGHT	
Superquip		250kg	
SUPPLIER PRODUCT ID	JDE#	PRICE BREAK	ORDERING CODE
055AM	764801	\$250-\$500	BA1

Bath Lifter		Band 2		
		SPECIFICATIONS		
		Bath lift Orca		
SUPPLIER		DIMENSIONS		
Invacare Ltd		3750mm seat width without side flaps 7150mm seat width with side flaps 580x285mm base area		
BRAND				
Aquatech				
SUPPLIER PRODUCT ID	JDE#	MAX USER WEIGHT	PRICE BREAK	ORDERING CODE
1470753	834603	135kg	\$500-\$750	S6
1471070	834865	170kg	\$750-\$1000	S7

MINISTRY OF HEALTH BAND 2 & 3 LIST EQUIPMENT

SHOWER & BATH

Shower Commode				Band 2
		SPECIFICATIONS		
		Junior Attendant propelled		
SUPPLIER		DIMENSIONS		
Cubro		360mm width between arms		
BRAND		MAX USER WEIGHT		
Viking II		120kg		
SUPPLIER PRODUCT ID	JDE#	PRICE BREAK	ORDERING CODE	
2346J360	875341	\$1000-\$1500	P32	
Accessories				
DESCRIPTION	JDE#	SUPPLIER PRODUCT ID	PRICE BREAK	ORDERING CODE
Closed seat	761791	75HPACB	\$250-\$500	P169
Open seat	761811	75HPAOB	\$250-\$500	P170

Shower Commode				Band 2
		SPECIFICATIONS		
		Junior Self propelled		
SUPPLIER		DIMENSIONS		
Cubro		360mm width between arms		
BRAND		MAX USER WEIGHT		
Viking II		120kg		
SUPPLIER PRODUCT ID	JDE#	PRICE BREAK	ORDERING CODE	
2348J360	875333	\$1500-\$2000	P34	
Accessories				
DESCRIPTION	JDE#	SUPPLIER PRODUCT ID	PRICE BREAK	ORDERING CODE
Closed seat	761791	75HPACB	\$250-\$500	P169
Open seat	761811	75HPAOB	\$250-\$500	P170

MINISTRY OF HEALTH BAND 2 & 3 LIST EQUIPMENT

SHOWER & BATH

Shower Commode				Band 2
		SPECIFICATIONS		
		Maxi viking		
SUPPLIER		DIMENSIONS		
Cubro		600mm width between arms		
BRAND		MAX USER WEIGHT		
Viking II		210kg		
SUPPLIER PRODUCT ID	JDE#	PRICE BREAK	ORDERING CODE	
2346M600	875405	\$1000-\$1500	BA41	
Accessories				
DESCRIPTION	JDE#	SUPPLIER PRODUCT ID	PRICE BREAK	ORDERING CODE
Closed seat	761539	75HPCM600	\$500-\$750	BA43

MINISTRY OF HEALTH BAND 2 & 3 LIST EQUIPMENT

TOILETING

Over Toilet Frame		Band 2	
		SPECIFICATIONS	
		Includes splash guard Bariatric Padded armrests	
SUPPLIER		DIMENSIONS	
Superquip Ltd		600mm width between arms 460 - 585 adjustable height	
BRAND		MAX USER WEIGHT	
Superquip		250kg	
SUPPLIER PRODUCT ID	JDE#	PRICE BREAK	ORDERING CODE
076AM	753328	\$250-\$500	BA3

MINISTRY OF HEALTH BAND 2 & 3 LIST EQUIPMENT

WHEELCHAIRS & SEATING

Wheelchair						Band 3
			SPECIFICATIONS			
			Self propelling Paediatric Folding			
SUPPLIER			DIMENSIONS			
Melrose			410 - 510mm adjustable depth			
BRAND			MAX USER WEIGHT			
Melrose Condor			100kg			
SUPPLIER PRODUCT ID	JDE#	WIDTH	DEPTH	PRICE BREAK	ORDERING CODE	
90050 10	835016	10 - 12"	10 - 14"	\$3000-\$4000	WC124	
90050 12	835024	12 - 14"	12 - 16"	\$3000-\$4000	WC125	
90050 14	835041	14 - 16"	14 - 18"	\$3000-\$4000	WC126	

Wheelchair					Band 2
			SPECIFICATIONS		
			Transit Tilt N Space		
SUPPLIER			DIMENSIONS		
Ebos Ltd			10 - 18" adjustable depth		
BRAND			MAX USER WEIGHT		
Sunrise Zippie			165kg		
SUPPLIER PRODUCT ID	JDE#	WIDTH	PRICE BREAK	ORDERING CODE	
Zippie Iris 10	834945	10"	\$2500-\$3000	WC120	
Zippie Iris 12	834953	12"	\$2500-\$3000	WC121	
Zippie Iris 14	834970	14"	\$2500-\$3000	WC122	
Zippie Iris 16	834988	16"	\$2500-\$3000	WC123	

MINISTRY OF HEALTH BAND 2 & 3 LIST EQUIPMENT

WHEELCHAIRS & SEATING

Wheelchair				Band 2
		SPECIFICATIONS		
		Self propelling Folding		
SUPPLIER		DIMENSIONS		
Allied Medical Ltd				
BRAND		MAX USER WEIGHT		
Karma		130kg , 20" =160kg		
SUPPLIER PRODUCT ID	JDE#	SEAT	PRICE BREAK	ORDERING CODE
KM8020QD1416AHA	767560	14 x 16	\$750-\$1000	WC50
KM8020QD1616AHA	773687	16 x 16	\$750-\$1000	WC1-SP
KM8020QD1618AHA	793979	16 x 18	\$750-\$1000	WC55
KM8020QD1816AHA	796571	18 x 16	\$750-\$1000	WC51
KM8020QD1818AHA	773695	18 x 18	\$750-\$1000	WC2-SP
KM8020QD2018AHA	767594	20 x 18	\$1000-\$1500	WC56
Accessories				
DESCRIPTION	JDE#	SUPPLIER PRODUCT ID	PRICE BREAK	ORDERING CODE
Stump support - Left	801385	KMSSL	\$50-\$250	WCSSL
Stump support - Right	801393	KMSSR	\$50-\$250	WCSSR

MINISTRY OF HEALTH BAND 2 & 3 LIST EQUIPMENT

WHEELCHAIRS & SEATING

Wheelchair					Band 2
			SPECIFICATIONS		
			Transit Folding		
SUPPLIER			DIMENSIONS		
Allied Medical Ltd					
BRAND			MAX USER WEIGHT		
Karma			130kg , 20" =160kg		
SUPPLIER PRODUCT ID	JDE#	SEAT	PRICE BREAK	ORDERING CODE	
KM8520F1416AHA	767607	14 x 16	\$750-\$1000	WC87	
KM8520F1616AHA	773708	16 x 16	\$750-\$1000	WC1-T	
KM8520F1816AHA	824608	18 x 16	\$750-\$1000	WC89	
KM8520F1618AHA	824595	16 x 18	\$750-\$1000	WC88	
KM8520F1818AHA	773716	18 x 18	\$750-\$1000	WC2-T	
KM8520F2018AHA	824624	20 x 18	\$1000-\$1500	WC47	
Accessories					
DESCRIPTION	JDE#	SUPPLIER PRODUCT ID	PRICE BREAK	ORDERING CODE	
Stump support - Left	801385	KMSSL	\$50-\$250	WCSSL	
Stump support - Right	801393	KMSSR	\$50-\$250	WCSSR	

Wheelchair					Band 2
			SPECIFICATIONS		
			Self propelling Folding		
SUPPLIER			DIMENSIONS		
Ebos Ltd			16 - 18" adjustable depth		
BRAND			MAX USER WEIGHT		
Sunrise Breezy			125kg		
SUPPLIER PRODUCT ID	JDE#	WIDTH	PRICE BREAK	ORDERING CODE	
Breezy Rubix SP14	834611	14"	\$1000-\$1500	WC79	
Breezy Rubix SP16	834620	16"	\$1000-\$1500	WC80	
Breezy Rubix SP18	834638	18"	\$1000-\$1500	WC81	
Breezy Rubix SP20	834646	20"	\$1000-\$1500	WC82	

MINISTRY OF HEALTH BAND 2 & 3 LIST EQUIPMENT

WHEELCHAIRS & SEATING

Wheelchair				Band 2
		SPECIFICATIONS		
		Transit Folding		
SUPPLIER		DIMENSIONS		
Ebos Ltd		16 - 18" adjustable depth		
BRAND		MAX USER WEIGHT		
Sunrise Breezy		125kg		
SUPPLIER PRODUCT ID	JDE#	WIDTH	PRICE BREAK	ORDERING CODE
Breezy Rubix T14	834654	14"	\$1000-\$1500	WC83
Breezy Rubix T16	834662	16"	\$1000-\$1500	WC84
Breezy Rubix T18	834671	18"	\$1000-\$1500	WC85
Breezy Rubix T20	834689	20"	\$1000-\$1500	WC86

Wheelchair				Band 2
		SPECIFICATIONS		
		Self propelling Folding		
SUPPLIER		DIMENSIONS		
Allied Medical Ltd				
BRAND		MAX USER WEIGHT		
Start M4 XXL		160kg		
SUPPLIER PRODUCT ID	JDE#	WIDTH	PRICE BREAK	ORDERING CODE
OB480F53=4000-50	834697	50cm	\$1500-\$2000	WC90
OB480F53=4000-55	834700	55cm	\$1500-\$2000	WC91
OB480F53=4000-58	834718	58cm	\$1500-\$2000	WC92

MINISTRY OF HEALTH BAND 2 & 3 LIST EQUIPMENT

WHEELCHAIRS & SEATING

Wheelchair					Band 3
			SPECIFICATIONS		
			Self propelling Folding		
SUPPLIER			DIMENSIONS		
Invacare Ltd					
BRAND			MAX USER WEIGHT		
Topaz 9000			318kg		
SUPPLIER PRODUCT ID	JDE#	WIDTH	PRICE BREAK	ORDERING CODE	
TPZ92218	834726	22 x 18"	\$3000-\$4000	WC93	
TPZ92220	834734	22 x 20"	\$3000-\$4000	WC94	
TPZ92418	834742	24 x 18"	\$3000-\$4000	WC95	
TPZ92420	834751	24 x 20"	\$3000-\$4000	WC96	

Wheelchair					Band 3
			SPECIFICATIONS		
			Self propelling Tilt N Space		
SUPPLIER			DIMENSIONS		
Invacare Ltd					
BRAND			MAX USER WEIGHT		
Solara 3G			113kg		
SUPPLIER PRODUCT ID	JDE#	WIDTH	WIDTH	PRICE BREAK	ORDERING CODE
SOLARA 3G-14SP	842128	12 - 16"	15 - 19"	\$4000-\$5000	WC259
SOLARA 3G-16SP	842136	14 - 18"	15 - 19"	\$4000-\$5000	WC260
SOLARA 3G-16SP	842144	14 - 18"	18 - 22"	\$4000-\$5000	WC261
SOLARA 3G-18SP	842152	16 - 20"	18 - 22"	\$4000-\$5000	WC262
SOLARA 3G-20SP	842161	18 - 22"	18 - 22"	\$4000-\$5000	WC263

MINISTRY OF HEALTH BAND 2 & 3 LIST EQUIPMENT

WHEELCHAIRS & SEATING

Wheelchair						Band 3
			SPECIFICATIONS			
			Transit Tilt N Space			
SUPPLIER			DIMENSIONS			
Invacare Ltd						
BRAND			MAX USER WEIGHT			
Solara 3G			113kg			
SUPPLIER PRODUCT ID	JDE#	WIDTH	WIDTH	PRICE BREAK	ORDERING CODE	
SOLARA 3G-14T	835121	12 - 16"	15 - 19"	\$4000-\$5000	WC115	
SOLARA 3G-16T	835147	14 - 18"	15 - 19"	\$4000-\$5000	WC116	
SOLARA 3G-16T	835155	14 - 18"	18 - 22"	\$4000-\$5000	WC117	
SOLARA 3G-18T	835163	16 - 20"	18 - 22"	\$4000-\$5000	WC118	
SOLARA 3G-20T	835171	18 - 22"	18 - 22"	\$4000-\$5000	WC119	

Wheelchair						Band 3
			SPECIFICATIONS			
			Self propelling Tilt N Space			
SUPPLIER			DIMENSIONS			
Ebos Ltd						
BRAND			MAX USER WEIGHT			
Sunrise Quickie			136kg			
SUPPLIER PRODUCT ID	JDE#	WIDTH	WIDTH	PRICE BREAK	ORDERING CODE	
Iris SP14	835032	14"	14 - 18"	\$3000-\$4000	WC103	
Iris SP14	835059	14"	18 - 22"	\$3000-\$4000	WC104	
Iris SP16	835075	16"	16 - 20"	\$3000-\$4000	WC105	
Iris SP16	835083	16"	18 - 22"	\$3000-\$4000	WC106	
Iris SP18	835091	18"	18 - 22"	\$3000-\$4000	WC107	
Iris SP20	835112	20"	18 - 22"	\$3000-\$4000	WC108	

MINISTRY OF HEALTH BAND 2 & 3 LIST EQUIPMENT

WHEELCHAIRS & SEATING

Wheelchair				Band 2	
			SPECIFICATIONS		
			Transit Tilt N Space		
SUPPLIER			DIMENSIONS		
Ebos Ltd					
BRAND			MAX USER WEIGHT		
Sunrise Quickie			136kg		
SUPPLIER PRODUCT ID	JDE#	WIDTH	WIDTH	PRICE BREAK	ORDERING CODE
Iris T14	834822	14"	14 - 18"	\$3000-\$4000	WC109
Iris T14	834831	14"	18 - 22"	\$3000-\$4000	WC110
Iris T16	834849	16"	16 - 20"	\$3000-\$4000	WC111
Iris T16	834873	16"	18 - 22"	\$3000-\$4000	WC112
Iris T18	834890	18"	18 - 22"	\$3000-\$4000	WC113
Iris T20	834911	20"	18 - 22"	\$3000-\$4000	WC114

MINISTRY OF HEALTH BAND 2 & 3 LIST EQUIPMENT

WHEELCHAIRS & SEATING

Ramp					Band 2
			SPECIFICATIONS		
			Threshold ramp Aluminium Non-skid surface		
SUPPLIER			DIMENSIONS		
Cubro			775mm width 90-215mm height adjustable		
BRAND			MAX USER WEIGHT		
EuroRamps			250kg		
SUPPLIER PRODUCT ID	JDE#	Length	PRICE BREAK	ORDERING CODE	
559-927MM	761133	927mm	\$500-\$750	RA18	
560-1720MM	760894	1720mm	Over \$1000	RA19	

Ramp					Band 2
			SPECIFICATIONS		
			Oversill ramp Two piece aluminium Non-skid surface		
SUPPLIER			DIMENSIONS		
Cubro			760mm width 70-215mm height adjustable		
BRAND			MAX USER WEIGHT		
EuroRamps			300kg		
SUPPLIER PRODUCT ID	JDE#	Length	PRICE BREAK	ORDERING CODE	
555-800MM	760991	800mm + 400mm flap	Over \$1000	RA30	
569-1200MM	760982	1200mm + 500mm flap	Over \$1000	RA31	